



Software Defined Networking and Architectures

Eugen Borcoci

University POLITEHNICA Bucharest,
Eugen.Borcoci@elcom.pub.ro



Acknowledgement

The **overview (State of the Art) part is compiled**, based on several public documents and different authors' and groups work: Future Internet conferences public material, research papers and projects, overviews, tutorials, etc.: (see Reference list).

The **ALICANTE –project case study** as an example of content/media –oriented architecture having SDN similarities is presented with permission of the ALICANTE Consortium.

This work is supported by **ALICANTE FP7 IP Project 248652: “Media Ecosystem Deployment Through Ubiquitous Content-Aware Network Environments”**.

<http://www.ict-alicante.eu/>



Software Defined Networking and Architectures



Motivation of this talk

- **Future Internet challenges** -> need to solve the current Internet limitation and ossification- as to support global integration of various forms of communications
 - Evolutionary approach
 - Clean slate approach
 - New trends

Software Defined Networks → Software Defined Internet Architectures

Cloud computing

(ICN/CCN) Information/Content Centric Networking, (CON) Content Oriented Networking, (CAN) Content Aware Networking, ...

Combinations



Software Defined Networking and Architectures



Motivation of this talk (cont'd)

- **This tutorial**
 - Overview of recent architectural proposals and technologies, studied in research groups but also included in industry development, aiming to bring more flexibility and efficiency to IP networking and even to the whole Internet architecture.
- **Topics**
 - **Software Defined Networks (SDN) architecture**
 - Control and data planes are decoupled
 - Increased flexibility
 - Network intelligence is more centralized
 - better and more flexible control of the resource management
 - overall image of the system in the control plane
 - programmability of the network resources.
 - *OpenFlow* protocol for communication between planes
 - Attractive also for media-oriented and real time apps/services



Software Defined Networking and Architectures



Motivation of this talk (cont'd)

■ Topics

- **SDN links to other technologies**
 - **Cloud computing**
 - Infrastructure as a Service (IaaS) and Network as a Service (NaaS)
 - **Content/information oriented/centric networking**
 - propose to significantly (revolutionary) change the traditional approach
 - by decoupling the content and location at network level
 - creating the possibility for media objects to be directly leveraged in network nodes
- **The above approaches : SDN/ Cloud computing/ ICN**
 - can be seen and developed as complementary
 - cooperating and supporting each other
 - aiming finally towards re-architecting the Internet



CONTENTS



1. Software Defined Networks (Basics)
2. SDN Applications
3. SDN-OpenFlow
4. SDN Extensions and Advanced Architectures
5. Other recent technologies- SDN approach
6. SDN-like architecture example : ALICANTE Project
7. Conclusions



CONTENTS



1. **👉 Software Defined Networks (Basics)**
2. SDN Applications
3. SDN-OpenFlow
4. SDN Extensions and Advanced Architectures
5. Other recent technologies- SDN approach
6. SDN-like architecture example : ALICANTE Project
7. Conclusions



1. Software Defined Networking



- **1.1 Introduction**
- Current network architectures only partially meet today's requirements of enterprises, carriers, and end users: open architectures, flexibility, programability, QoS, flexible resource management, etc.
- **Current network technologies limitations**
 - **Complexity that leads to stasis:**
 - Current networking : many discrete sets of protocols connecting hosts reliably over arbitrary distances, link speeds, and topologies
 - Protocols are defined in isolation, to solve a specific problem
 - No benefit of any fundamental abstractions -> complexity
 - To add or move any device, IT admin. must (re)configure multiple HW/SW entities using device-level management tools
 - should consider topology, vendor switch model, SW version, etc.
 - Network complexity -> today's networks reconfigurations are performed relatively in static way (to minimize the risk of service disruption)



1. Software Defined Networking



- **1.1 Introduction**
- **Current network technologies limitations (cont'd)**
- **Complexity that leads to stasis:**
 - **The static nature of networks**
 - It is not good for today's dynamic server environment, (server virtualization, VM migration)
 - applications are distributed across multiple virtual machines (VMs), which exchange traffic flows with each other.
 - VM migration : challenge for many aspects of traditional networking (addressing schemes, namespaces segmented, routing-based design).
- **Limited capability for dynamic differentiated QoS** levels because of – usually static provisioning
- **Not enough capability to dynamically adapt** to changing traffic, application, and user demands.



1. Software Defined Networking



- **1.1 Introduction**
- **Current network technologies limitations (cont'd)**
- **Inconsistent policies:**
 - Network-wide policy implementation -> have to configure thousands of devices and mechanisms
 - The complexity of today's networks makes it very difficult to apply a consistent set of access, security, QoS, and other policies
- **Scalability issues:**
 - Complex network (10**5 network devices in data centers)
 - **Over-subscription** based on predictable traffic patterns **is not working well**; in today's virtualized data centres, traffic patterns are highly dynamic and it is difficult to predict
 - Mega-operators (e.g. Google, Yahoo!, Facebook), face **scalability challenges**
 - The number of of computing elements exploded
 - data-set exchanges among compute nodes can reach petabytes



1. Software Defined Networking



- **1.1 Introduction**
- **Current network technologies limitations (cont'd)**
- **Scalability issues (cont'd)**
 - Need “hyper-scale” networks to provide high-performance, low-cost connectivity among many physical servers (need automation)
 - Carriers have to deliver ever-higher value, better-differentiated services to customers
 - Multi-tenancy : the network must serve large groups of users with different applications and needs
- **Vendor dependency**
 - Carriers/enterprises want rapid response to changing business needs or user demands
 - Their ability to respond is limited by vendors’ equipment product cycles (years)
 - Lack of standard, open I/F - limits the ability of network operators to tailor the network to their individual environments



1. Software Defined Networking



- **1.1 Introduction**
- **Need for a new network architecture**
 - **Changing traffic patterns:**
 - *Traffic patterns have changed significantly* within the enterprise data center: today's applications access different DBs and servers, creating a high M2M traffic before returning data to the end user device (different from classic client-server applications)
 - *Users- network traffic patterns changing:* they want access to corporate content and apps. from any type of device, anywhere, at any time
 - Enterprises : need of computing model, which might include a *private public or hybrid cloud*, resulting in additional traffic across the wide area network
 - **Need of flexible access to IT resources:**
 - *Increasing usage of mobile personal devices* such as smart-phones, tablets, and notebooks to access the corporate network
 - Need to accommodate these personal devices while *protecting corporate data and intellectual property* and meeting compliance mandates



1. Software Defined Networking



- **1.1 Introduction (cont'd)**
- **Need for a new network architecture (cont'd)**
 - **Cloud services development:**
 - Significant growth of public and private cloud services (SaaS, PaaS, IaaS, NaaS,..) on demand and à la carte
 - IT's needs for cloud services : security, compliance, auditing requirements, elastic scaling of computing, storage, and network resources,etc.
 - **Need for more bandwidth:**
 - today's high volume of data requires massive parallel processing on thousands of inter-connected servers
 - demand for additional network capacity in the data center
 - data center networks : need of scaling to very large size, while maintaining any-to-any connectivity
 - Media/content traffic high increase- need of more bandwidth



1. Software Defined Networking



■ 1.1 Introduction

- Recent industry/research effort resulted in new approaches:
 - **Software- Defined Networking (SDN)** – aiming to transform networking architecture
 - **Open Networking Foundation** (ONF- non-profit industry consortium) → OpenFlow I/F specifications for SDN
- **SDN architecture major characteristics:**
 - the *Control Plane (CPI)* and *Data Planes (DPI)* are decoupled
 - network intelligence and state are logically centralized
 - underlying network infrastructure is abstracted from the applications
- **Promises for enterprises and carriers :**
 - higher programmability opportunities, automation, and network control
 - enabling them to build highly scalable, flexible networks
 - fast adapt to changing business needs
- *Source: Software-Defined Networking: The New Norm for Networks ONF White Paper April 13, 2012*
- *Note: after many years of strongly defending a completely distributed control approach in TCP/IP architecture- now a more centralized approach is proposed*



1. Software Defined Networking



■ 1.1 Introduction

- SDN + OpenFlow I/F (first standard) advantages:
 - *high-performance, granular traffic control* across multiple vendors' network devices
 - *centralized management and control* of networking devices improving automation and management
 - *common APIs abstracting the underlying networking* details from the orchestration and provisioning systems and applications;
 - *flexibility*: new network capabilities and services with no need to configure individual devices or wait for vendor releases
 - *programmability* by operators, enterprises, independent software vendors, and users (not just equipment manufacturers) using common programming environments
 - *Increased network reliability* and *security* as a result of centralized and automated management of network devices, uniform policy enforcement, and fewer configuration errors



1. Software Defined Networking



- **1.1 Introduction**
- SDN + OpenFlow advantages (cont'd):
 - *more granular network control* with the ability to apply comprehensive and wide-ranging policies at the session, user, device, and application levels
 - *better end-user experience* as applications exploit centralized network state information to seamlessly adapt network behavior to user needs
 - *protects existing investments* while future-proofing the network
 - **With SDN, today's static network can evolve into an extensible service delivery platform capable of responding rapidly to changing business, end-user, and market needs.**



1. Software Defined Networking



- **1.2 Earlier technologies related to SDN**
- **Open Signaling [3]**
 - **OPENSIG WG** (~1995)- attempt to make Internet, ATM, and mobile networks more open, extensible, and programmable"
 - Ideas: **separation between the communication HW and control SW**
 - Proposal: access to the network HW via open, programmable network I/Fs
 - allow new services deployment through a distributed programming environment.
- **IETF WG** - > **General Switch Management Protocol (GSMP)**
 - general purpose protocol to control a label switch.
 - establish and release connections across the switch
 - add/delete leaves on a multicast connection
 - manage switch ports, request configuration information, statistics
 - manage switch resources
 - GSMPv3, June 2002, WG has been concluded



1. Software Defined Networking



- **1.2 Earlier technologies related to SDN (cont'd)**
- **Active Networking [4]**
 - ~1995-2000 - idea of a programmable network infrastructure (for customized services)
 - Approaches
 - (1) user-programmable switches, in-band data transfer and out-of-band management channels
 - (2) control information organized in “capsules”, which were program fragments that could be carried in user messages; program fragments would then be interpreted and executed by routers.
 - No large scale / significant success in practice - issues: security and perf.
- **4D Project [5]**
 - ~2004, a clean slate design
 - separation between the routing decision logic and the protocols governing the interaction between network elements.
 - “decision” plane having a global view of the network,
 - serviced by a “dissemination” and “discovery” plane, for control of a “data plane” forwarding
 - Consequences: NOX = operating system for networks in OF context



1. Software Defined Networking



- **1.2 Earlier technologies related to SDN (cont'd)**
- **NETCONF, [6], 2006**
 - IETF Network Configuration WG (still active) : NETCONF defined a management protocol for modifying the configuration of network devices.
 - network devices have APIs - (to send /retrieve) configuration data
 - **still - no separation Control/Data Plane**
 - A network with NETCONF is not fully programmable (new functionality should be implemented at both the network device and the manager)
 - NETCONF primarily aid automated configuration and not for enabling direct control of state data
 - It can be used in parallel on hybrid switches supporting other solutions that enable programmable networking
- **Ethane, [8], 2006- precursor to SDN**
 - new network architecture for enterprise networks
 - centralized controller to manage policy and security in a network
 - two components:
 - a controller to decide if a packet should be forwarded
 - Ethane switch : a flow table and a secure channel to the controller



1. Software Defined Networking



- 1.2. Earlier technologies related to SDN (cont'd)
- IETF WG ForCES Forwarding and Control Element Separation, 2003, [7].
 - A parallel approach to SDN
 - some common goals with SDN and ONF
 - Differences:
 - ForCES: the internal network device architecture is redefined as the control element separated from the forwarding element, but the **combined entity is still represented as a single network element to the outside world**
 - Aim: to combine new forwarding hardware with third-party control within a single network device where the separation is kept within close proximity (e.g., same box or room)
 - **SDN: Contrl Plane (CPI) is totally moved from net device**
 - FORCES published docs on : arch. framework, interactions, modelling language, forwarding element (FE) functions, protocol between Ctrl and FE



1. Software Defined Networking



- **1.3 Early SDN products**
- **First SDN products and activities examples**
- 2008: Software-Defined Networking (SDN) : NOX Network Operating System [Nicira]; OpenFlow switch interface [Stanford/Nicira]
- 2011: Open Networking Foundation (72 members) : Board: Google, Yahoo, Verizon, DT, Msoft, F'book, NTT ; Members: Cisco, Juniper, HP, Dell, Broadcom, IBM,.....



1. Software Defined Networking



■ 1.4 SDN Basic Architecture

- **Evolutionary**
- **CPI and DPI are separated**
- Network intelligence is (logically) centralized in SW-based SDN controllers, which maintain a global view of the network.
- Execute CPI SW on general purpose HW
 - Decoupled from specific networking HW
 - CPI can use commodity servers
- Data Plane (DPI) is programmable
- Maintain, control and program data plane state from a central entity
- **The architecture defines the control for a network** (and not for a network device) The network appears to the applications and policy engines as a single, logical switch
- This simplified network abstraction can be efficiently programmed

1.4 SDN Basic Architecture

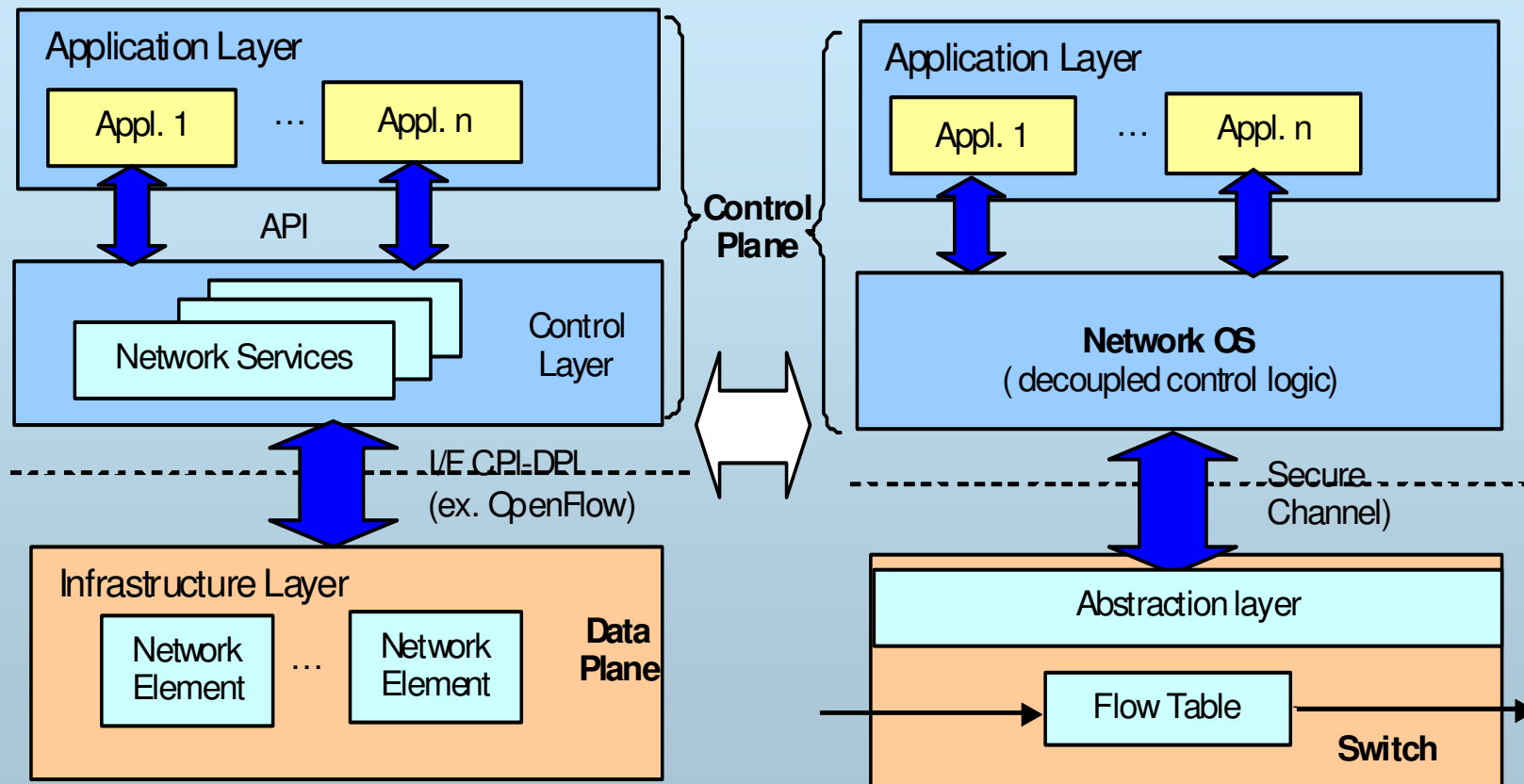

SDN Generic Architecture



1. Software Defined Networking



- **1.4 SDN Basic Architecture**
- **Control Plane**
 - **Control Applications/Program**
 - operates on view of network :
 - performs different functions (routing, traffic engineering, QoS, security, etc.)
 - **Input:** global network view (graph/database)
 - **Output:** configuration of each network device
 - Control program is not a distributed system
 - Abstraction hides details of distributed state
 - **Network OS:** distributed system that creates a consistent, global and up-to-date network view
 - In SDN it runs can on controllers (servers) in the network
 - It creates the “lower layer” of the Control Plane
 - Examples: NOX, ONIX, Trema, Beacon, Maestro, ...
- **Data Plane** : forwarders/switches (Forwarding elements -FE)
 - NOS uses some abstraction to:
 - Get state information from FE
 - Give control directives to FE



1. Software Defined Networking



- **1.4 SDN Basic Architecture**
- **Advantages**
- **Centralization allows:**
 - To alter network behavior in real-time and faster deploy new applications and network services (hours, days not weeks or months as today).
 - flexibility to configure, manage, secure, and optimize network resources via dynamic, automated SDN programs (not waiting for vendors) .
- **APIs facilitate** implementation of:
 - common network services: routing, multicast, security, access control, bandwidth management, QoS, traffic engineering, processor and storage optimization, energy usage
 - policy management, custom tailored to meet business objectives
 - Easy to define and enforce consistent policies across both wired and wireless connections on a campus
- Manage the entire network : intelligent orchestration and provisioning systems



1. Software Defined Networking



- **1.4 SDN Basic Architecture**
- **Advantages (cont'd)**
 - ONF studies **open APIs** to promote **multi-vendor management**:
 - possibility for **on-demand resource allocation, self-service provisioning**, truly virtualized networking, and secure cloud services.
 - SDN control and applications layers, business apps can operate on an **abstraction of the network**, leveraging network services and capabilities without being tied to the details of their implementation.
- **Open SDN issues/problems**
 - Balance between distribution – centralization (physical/logical)
 - Scalability
 - How many controllers
 - Their location
 - Synchronization
 - Reliability



1. Software Defined Networking



1.4 SDN Basic Architecture

Network OS:

- Distributed system that creates a consistent, updated network view
- Executed on servers (controllers) in the network
- Examples: NOX, ONIX, HyperFlow, Floodlight, Trema, Kandoo, Beacon, Maestro,..

Uses forwarding abstraction in order to:

- Collect state information from forwarding nodes
- Generate commands to forwarding nodes

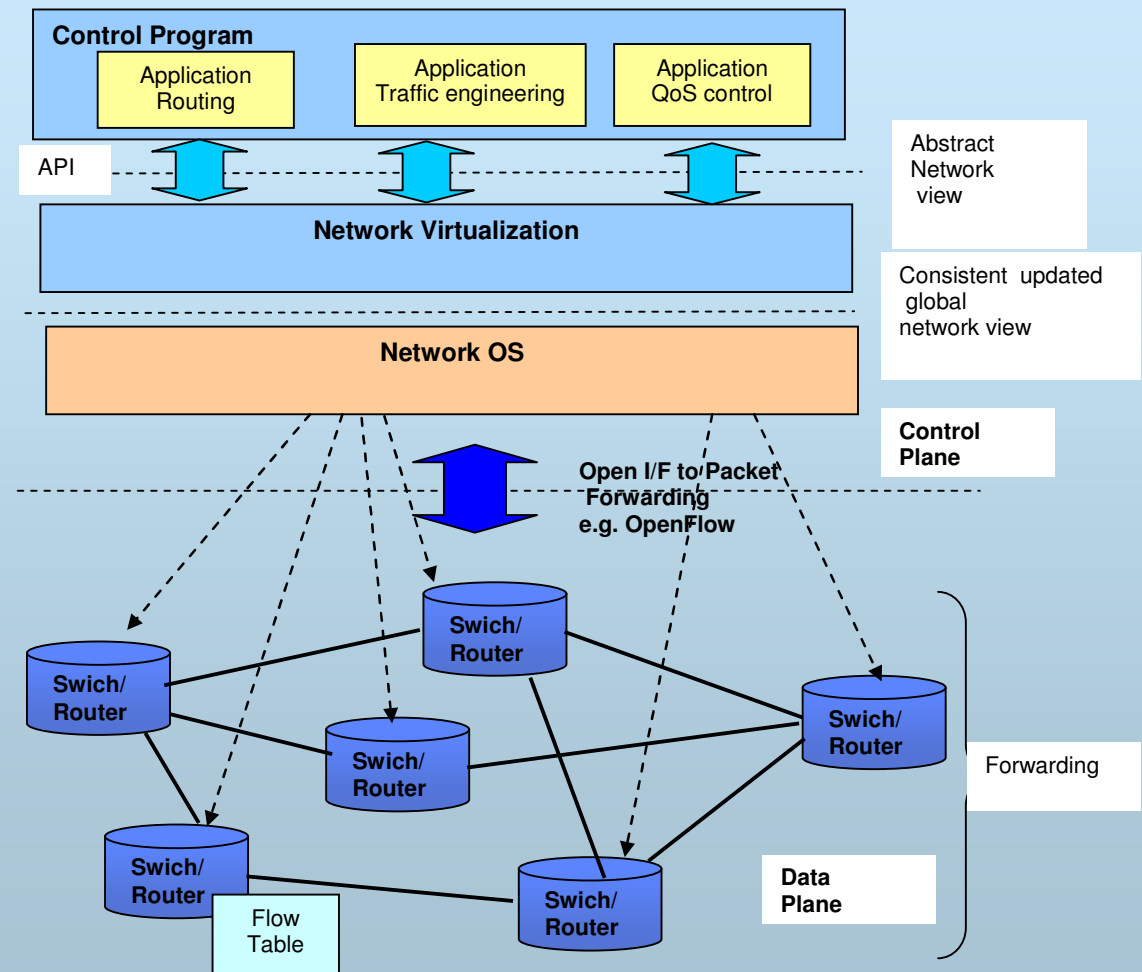



1. Software Defined Networking



- **1.4 SDN Basic Architecture**
- **OpenFlow summary**
 - the **first SDN standard** communications: CPI-DPI I/F
 - allows direct access to the Fwd. Plane of network devices (switches and routers), both physical and virtual (hypervisor-based)
 - allows to move network control out of the networking switches to logically centralized control software
 - can be compared to the instruction set of a CPU
 - specifies basic primitives to be used by an external SW application to program the FwdPI (~ instruction set of a CPU would program a computer system)



1. Software Defined Networking



- **1.4 SDN Basic Architecture**
- **OpenFlow summary**
 - uses the *concept of flows* to identify network traffic based on pre-defined match rules that can be statically or dynamically programmed by the SDN control SW
 - allows IT admin to define how traffic should flow through network devices based on parameters such as usage patterns, applications, and cloud resources
 - allows the network to be programmed on a per-flow basis (provides – if wanted- extremely granular control), enabling the network to respond to real-time changes at the application, user, and session levels

- **1.4 SDN Basic Architecture: Open Flow**
- *Source Ref1 [1]: “OpenFlow: Enabling Innovation in Campus Networks”- N.McKeown, T.Anderson, H.Balakrishnan, G.Parulkar, L.Peterson, J.Rexford, S.Shenker, J.Turner*

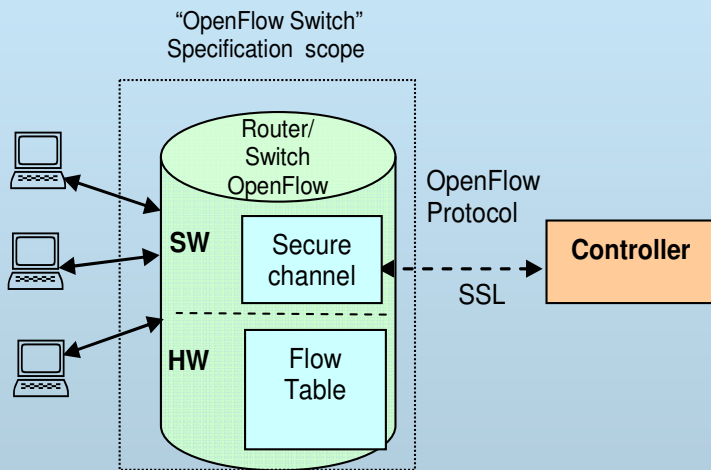

Ref1: Figure 1: Idealized OpenFlow Switch. The Flow Table is controlled by a remote controller via the Secure Channel.

In Port	VLAN ID	Ethernet			IP			TCP	
		SA	DA	Type	SA	DA	Proto	Src	Dst

Table 1: The header fields matched in a “Type 0” OpenFlow switch.

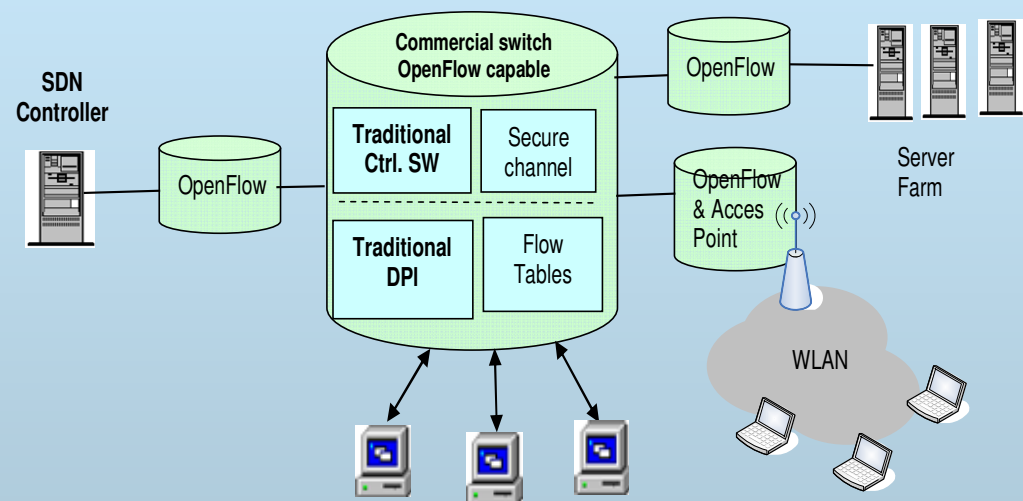

Ref1: Figure 2: Example of a network of OpenFlow-enabled commercial switches and routers.



CONTENTS



1. Software Defined Networks (Basics)
2.  **SDN Applications**
3. SDN-OpenFlow
4. SDN Extensions and Advanced Architectures
5. Other recent technologies- SDN approach
6. SDN-like architecture example : ALICANTE Project
7. Conclusions



2. SDN Applications



- **Enterprise Networks**
- SDN can be used to Improve management
 - to unify M&C
 - to programmatically enforce/ adjust network policies as well as help net monitoring and tune performance.
 - to eliminate middleboxes (NAT, firewalls, load balancers, access control, DPI, etc.) and integrating their functionality within the controller
 - configuration changes (currently- common networks instability source) can be performed in a more flexible and consistent way
 - a set of high-level abstractions are proposed that allow admin to update the entire network
 - packets are processed in consistent way at network level



2. SDN Applications



■ Data Centers

- High volume and dynamic traffic, large scale
- Management and policy enforcement is critical especially to avoid service disruption.
- Still some Data Center are provisioned based on estimation of peak demand
 - (-) high percentage of time under-utilization)
 - (+) but answer is very fast to high demand

- Energy consumption – important in big Data Centers (10-20% for networking) → need of better energy management
 - Proposal: SDN based Network-wide power management, (elastic tree, savings 20-65% depending on traffic conditions-have been shown)

 - Savings can be increased if used in cooperation with server management and virtualization
 - controlling the migration of VMs as to increase the number of machines and switches that can be shut down
 - however such traffic management must be balanced with scalability and performance overheads.



2. SDN Applications



■ Data Centers (cont'd)

- Issues: [2] :OF sometimes excessively centralises control processing while only few “significant” flows need to be managed → bottlenecks in the control communication (if fine granularity is wanted)
- Solutions: **proactive policies and wild-card rules**, but the cost is paid with less to manage traffic and gather statistics.
- Proposals done: design changes to
 - keep control of flows as much as possible in the data plane while maintaining enough visibility at controller level for effective flow management.
 - pushing back again responsibility on many flows the switches and adding more efficient statistics collection mechanisms, for significant" flows (e.g. long-lived, high-throughput) identified and managed by the controller.
 - Effect: reducing the control overhead and having fewer flow table entries



2. SDN Applications



- **Infrastructure-based Wireless Access Networks**
- **OpenRoads project [21]**
 - users move across different wireless infrastructures, managed by various providers.
 - SDN-based architecture, backwards-compatible, yet open and sharable between different SPs
 - testbed using OF-enabled wireless devices such as WiFi APs and WiMAX base stations controlled by NOX and Flowvisor controllers
 - Result: improved performance on handover events.
- Subsequent work addresses specific requirements and challenges in deploying a software-defined cellular network.



2. SDN Applications



- **Infrastructure-based Wireless Access Networks**
- **Odin[22] : programmability in enterprise wireless LAN environments.**
 - - it builds an AP abstraction at controller level,
 - separating the association state from the physical AP
 - enabling proactive mobility management and load balancing without changes to the client.
- **OpenRadio[23] : programmable wireless data plane**
 - flexibility at the PHY and MAC layers
 - provide a modular I/Fs able to process traffic subsets using WiFi, WiMAX, 3GPP LTE-Advanced, etc.
 - Separation of the decision and forwarding planes allows:
 - -an operator may express decision plane rules and corresponding actions
 - assembled from processing plane modules (e.g., FFT, decoding, etc)



2. SDN Applications



■ Service Provider -SDN Approach

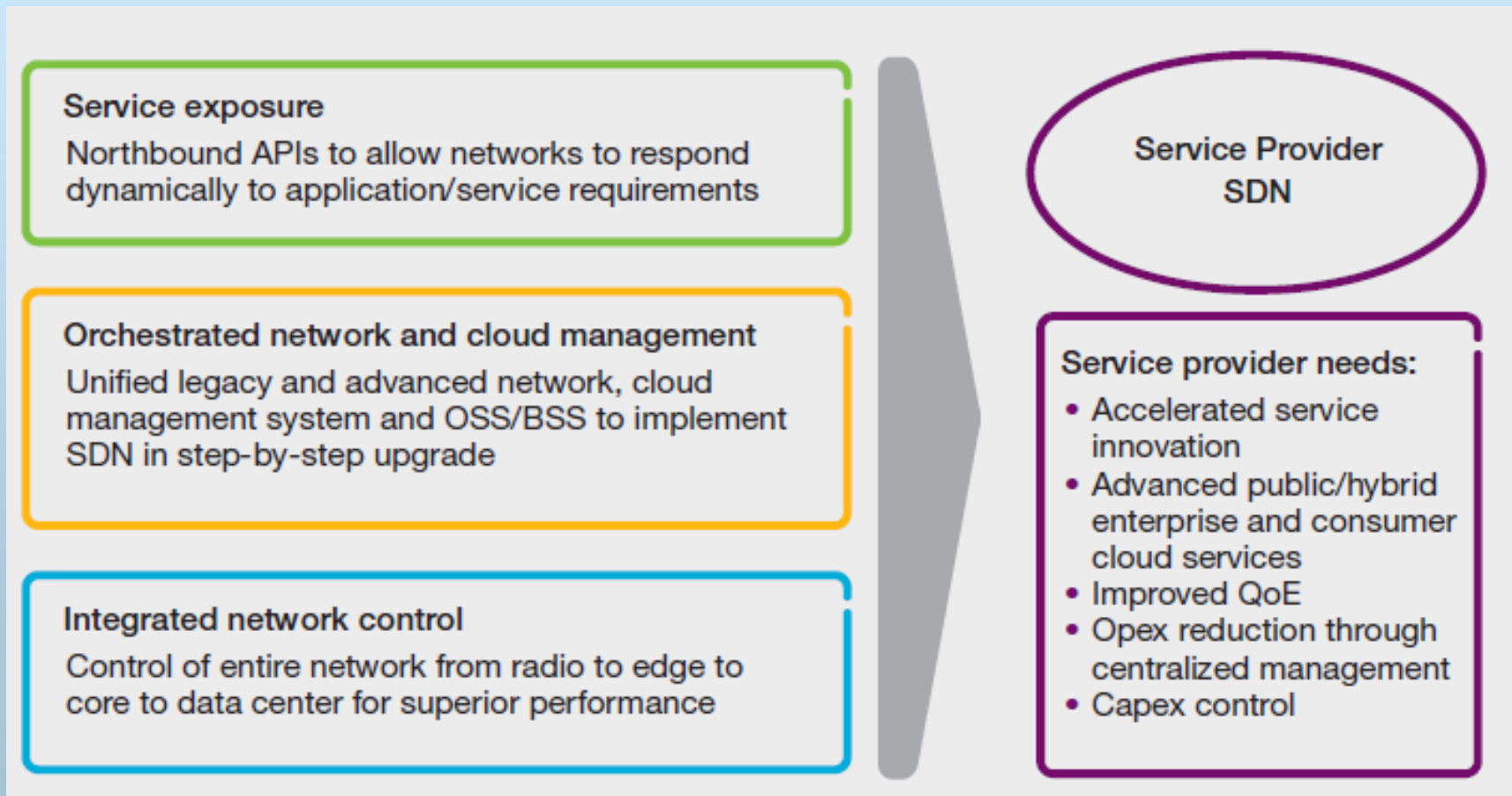

Source: SDN: the service provider perspective, Ericsson Review, February 21, 2013

- Service Provider –SDN approach

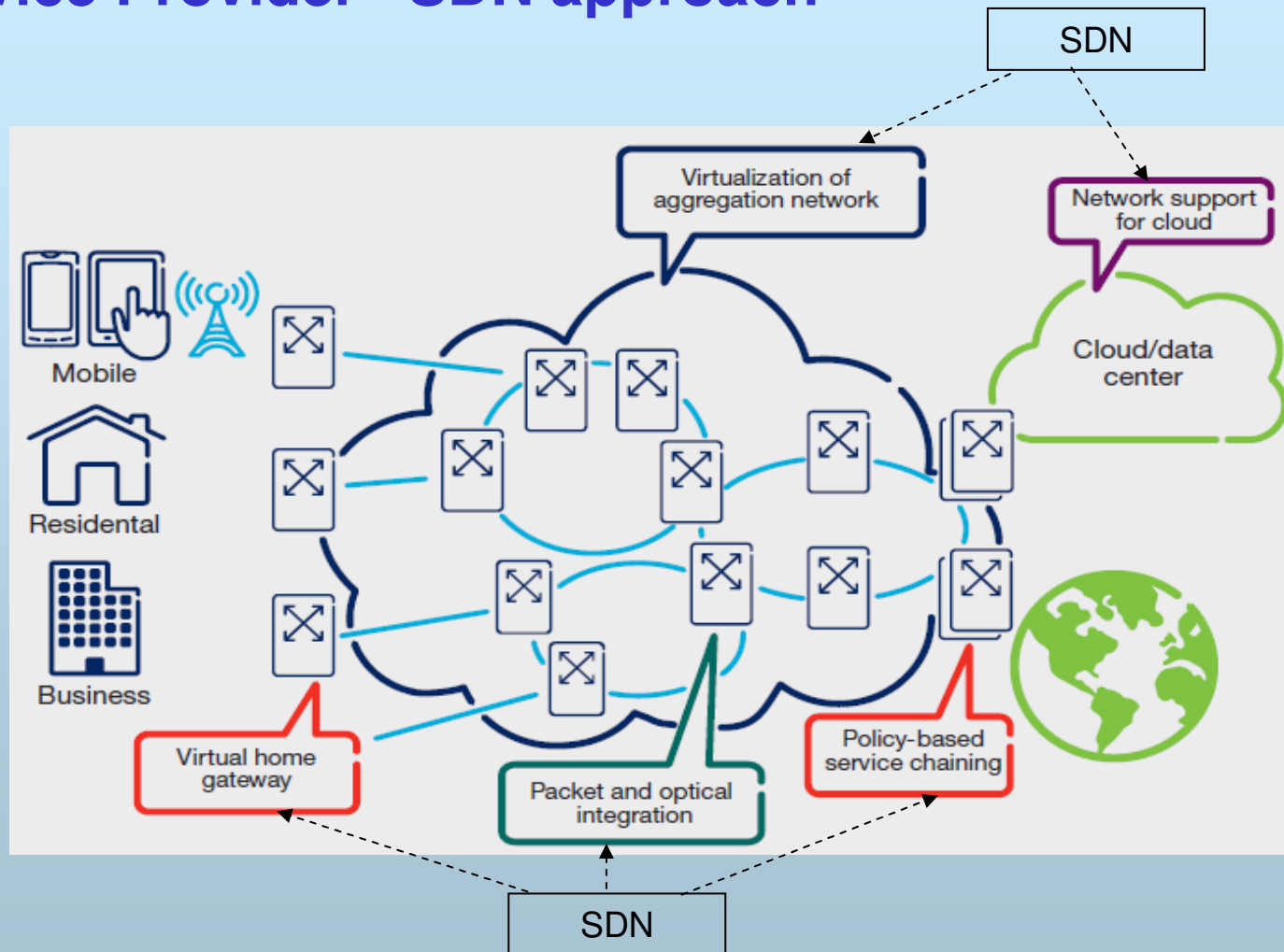

Source: *SDN: the service provider perspective*, Ericsson Review, February 21, 2013

NetWare 2013 Conference, August 25, 2013, Barcelona



2. SDN Applications



- **Service Provider -SDN Approach**

- **Aggregation/access and mobile-backhaul networks (AAN)**
 - large number of nodes and relatively static tunnels – for traffic grooming of many flows
 - stringent requirements : reliability and short recovery times.
 - Generic backhaul solution technologies : L2, IP, IP/MPLS
 - Usually AAN is configured statically : - centralized management system + point of touch to every network element

- **Building a centralized SDN controller is natural for backhaul solutions.**
 - Controller element (CE) can be hosted on a telecom-grade server or on an edge router provides
 - Operational difference (AAN- SDN network)- (AAN-traditional network) : the number of touch points required to provision and operate the domain
 - ***SDN: only a few points are needed to control the connectivity for the entire net-work.***



2. SDN Applications



- **Service Provider –SDN approach**
- **Aggregation/access and mobile-backhaul networks (AAN) (cont'd)**
 - **Example:**
 - *Current:* AAN: 10^{**2} - 10^{**3} nodes ; distributed IGP, LDP/MPLS
 - *New:* SDN can simplify and increase the scalability of provisioning and operating by pulling together the configuration of the whole network into just a few control points.
 - Control Element (CE) treats the underlying FE as remote line cards of the same system and control them via OpenFlow
- SDN: any kind of connectivity model is feasible (i.e. FE: L2, L3); from a forwarding point of view, the same model is used
- **Network resilience**
 - CE precompute and pre-install back-up routes and then protection switching is handled by the network elements for fast failover
 - or, CE can reroute around failures, in case multiple failures occur, or in scenarios having less stringent recovery requirements.
- From the outside, the entire *network segment appears to be one big Provider Edge (PE) router*
 - neighbors of the SDN-controlled area cannot tell the difference between it and a traditional network.



2. SDN Applications



- **Service Provider –SDN approach**

- **Dynamic service-chaining** (source: Ericsson)
 - Usually for inline services (DPI, firewalls (FWs), NAT, etc.), operators use special middle-boxes hosted on HW/VMs.
 - *Service chaining is required* to route certain subscriber traffic through more than one such service.

 - **Today: no protocols or tools to perform flexible, dynamic traffic steering**
 - Currently solutions : static or non-flexible solutions

 - **Via Dynamic service-chaining**
 - one can optimize the use of special services by selectively steering traffic through specific services or bypassing them (avoid over-dimensioning-> capex savings)

 - operators can offer : virus scanning, firewalls, content filters through an automatic selection and sub-scribe portal, etc.



2. SDN Applications



Service Provider –SDN approach

- **Dynamic service-chaining (cont'd)**
- SDN - can support **dynamic service chaining** (e.g. Ericsson - proof of concepts)
- logically centralized OF-CE manage switches and middleboxes
 - service chains can be differentiated on subscriber behavior, application, traditional 5-tuple, required service
 - Service paths are unidirectional- can be different for upstream and downstream traffic.
 - Traffic steering has two phases
 - 1. It classifies incoming packets and assigns a service path to them based on predefined policies.
 - 2. Packets are then forwarded to the next service, based on the current position in their assigned service path
 - No repeating classification is required; hence the solution is scalable.
- The SDN CE can flexibly set up and reconfigure service chains
- The dynamic reconfiguration of service chains needs a mechanism to handle notifications sent from middleboxes to the controller.
 - -e.g. , the DPI engine notifies CE (via extended OF) that it has recognized a video flow.



2. SDN Applications



- **Service Provider - SDN approach**
- **Dynamic service-chaining (cont'd)**

- **Virtual Network System (VNS) - concept** (source: Ericsson)
 - VNS: domain of the network with centralized CPI (this excludes some traditional control agents)
 - API- OpenFlow, controls the fwd.
 - VNS can create north-bound I/Fs
 - APIs to support creation of new features, such as service chaining

- The services provided by the network may reside on devices located in different parts of the network, or within an edge router –e.g. Ericsson's *Smart Services Router (SSR)*

- Service chains are programmed (cf. operator policies) based on a combination of information from the different layers (L2-L4. ..)

- **Service Provider -SDN approach**
- **Dynamic service-chaining (cont'd) - example**
 - Traffic goes first through DPI + FW
 - After flow type has been determined (DPI) the operator may decide to modify the services applied to it.

E.g.: internet video stream flow

- it may no longer need to pass the FW service after the service type has been detected, the sub-subsequent packets of the same flow may no longer need to pass the DPI service either
(blue path)

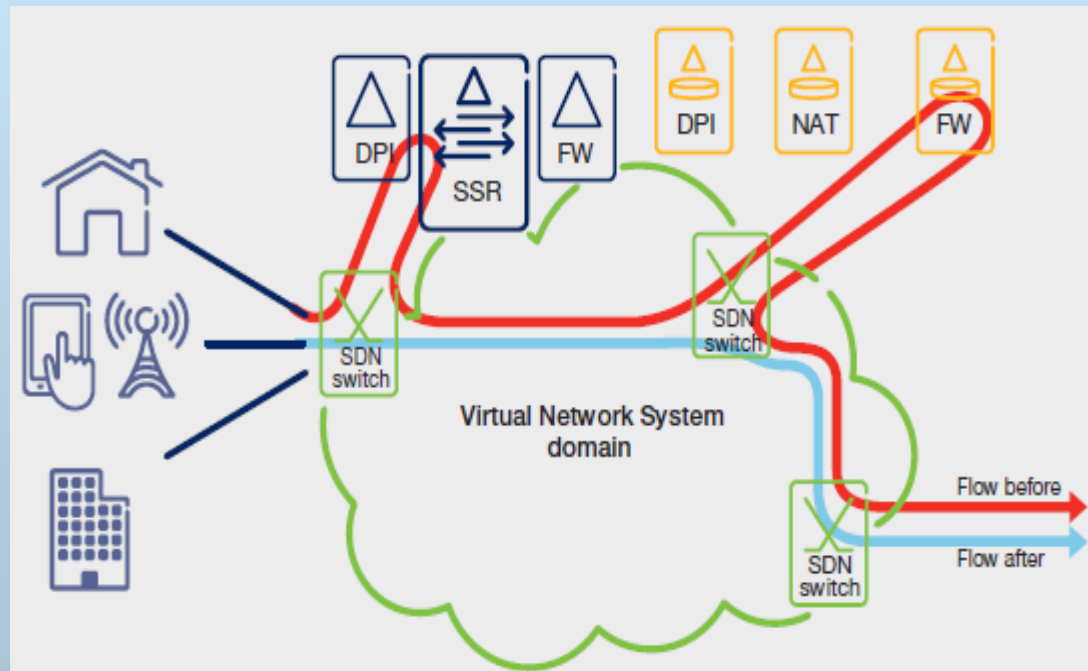

Source: *SDN: the service provider perspective, Ericsson Review, February 21, 2013*



2. SDN Applications



- **Service Provider -SDN Approach**
- **Packet-optical integration**
 - SDN : opportunity to solve some *optical packet networking challenges*
 - SDN can simplify multi-layer coordination and optimize resource allocation at each layer by redirecting based on the specific traffic requirements and the best serving layer.
 - **Current:** layered set of separated media coordinated in a static manner
 - **SDN :** packet-optical infrastructure can be more fluid, with a unified recovery approach and an allocation scheme based on real-time link utilization and traffic composition
 - ONF still has to adapt OpenFlow to cope with optical constraints.
 - **A hybrid architecture proposal can be attractive:**
 - **OpenFlow drives the packet domain**
 - **GMPLS still controls the optical domain**
 - **advantage:**
 - one still utilizes the extensive optical capabilities of GMPLS
 - instead working to extend OF with optical capabilities, it allows focus on the actual integration of optical and packet domains applications that utilize the flexibility of a unified SDN controller.



2. SDN Applications



- **Home gateway control**
- **Virtual Home Gateway (VHG) concept** : new home-network architecture improving service delivery and management.
 - SDN can be used between the Residential Gateway (RG) and the edge network – moving most GW functionalities into an embedded execution environment.
 - **RG Virtualization**
 - reduces its complexity
 - provides greater granularity in remote-control management, extensible to every home device
 - increases the RG life, cutting maintenance costs, accelerating time to market for new services
 - **VHG can**
 - offer seamless and secure remote profile instantiation extending the boundaries of a home network without compromising security
 - provide tools to configure and reconfigure middleboxes dynamically,
 - provide specific connectivity requirements for a third-party service
 - enables operators to offer personalized applications to sub-scribers.
- The architecture places an *operator-controlled bridge* (e.g. Ericsson) at the customer's premises instead of a complex router,
 - the L3-L7 functionalities migrate to the IP edge or into the operator cloud
- Using SDN between the IP edge and the switch → fine-grained control for switch dynamic configuration



2. SDN Applications



- **Home Networks (HN) and Small Business**
- **Several projects :**
 - SDN used in smaller networks, (home or small businesses)
 - need for more careful network management and tighter security
 - avoid complex admin at each home/business
- **Managing HNs [25]** by making the **network gateway/controller to act as a HN Data Recorder** (e.g. logs for troubleshooting or other purposes).
- **Outsourcing management to third-party experts [26]:** remote control of programmable switches and the appl. of distributed network monitoring and inference algorithms used to detect security problems.
- Alternative approach [27]: a HN can be managed by the users who better understand the dynamics and needs of their environment.
 - SDN can provide users a view into how their network (single point of control)
- **Anomaly Detection System (ADS) [28]** in a programmable HN can accurately identify malicious activity as compared to one deployed at the ISP.
 - The ADS algorithm could operate alongside other controller services, such as a HomeOS that may react to suspicious activity and report anomalies to the ISP or local administrator.



2. SDN Applications



■ Bandwidth on Demand (BWoD)

- WAN bandwidth demand ratio *peak info rate/mean rate* ~ 10 to 20 (cloud networking, ad hoc inter-enterprise collaboration, etc.)
 - with the peaks last from less than an hour to several weeks or more.
- Contracting *Peak Information Rate (PIR)* is costly and wasteful.
- *Bandwidth on Demand (BWoD)* – dynamically adjustable is wanted (pay what you consume)
- Connection types: subscribers; subscriber to a service GW (e.g., a cloud data center); from the subscriber to a third-party interconnect point.
-
- Current model of BWoD services (limited number of operators)
 - **Lack of automation** → difficult to roll out self-provisioned services and respond to time-sensitive changes in bandwidth requirements.
 - customers are given some control invoke the services through a portal but very **limited in scope**.
 - **Frequent changes** in a distributed control environment sometimes lead to transient overloads → **congestion and instability**.
 - Lack of a standard I/F → operators today must interface their OSS/BSS systems to a vendor-specific network infrastructure. (need to redesign control applications for each vendor)



2. SDN Applications



- **Bandwidth on Demand (BWoD)**
- **SDN Solution** : BWoD from an OF - SDN architecture with a programmatic north API
 - operators have centralized, granular control over the networking infrastructure.
- Customers can *automatically request dynamic changes to bandwidth allocation* and other QoS parameters at the packet and/or optical layers, either immediately or scheduled in the future.
- The SDN control layer can leverage topology-aware path computation to cost-effectively enable bandwidth on demand.
- SDN : real-time topological view of the network, enables network virtualization, and allows *network bandwidth reservation* to provide guaranteed *performance on a per-connection or flow basis to meet SLA requirements*.



2. SDN Applications



- **Bandwidth on Demand (BWoD)**
- SDN's global view of network resource supply and customer demands → intelligent and dynamic BWoD pricing.
 - An analytics engine could evaluate current supply and demand as well as historical temporal demand peaks and supply.
 - Through continual learning of the price elasticity of demand, these adjustments can become more refined, enabling the analytics engine to maximize network revenue per bit.
- Network virtualization allows operators to leverage the same networking and operational infrastructure on which they deliver traditional services to create BWoD services and new billing models.

- Bandwidth on Demand (BWoD)

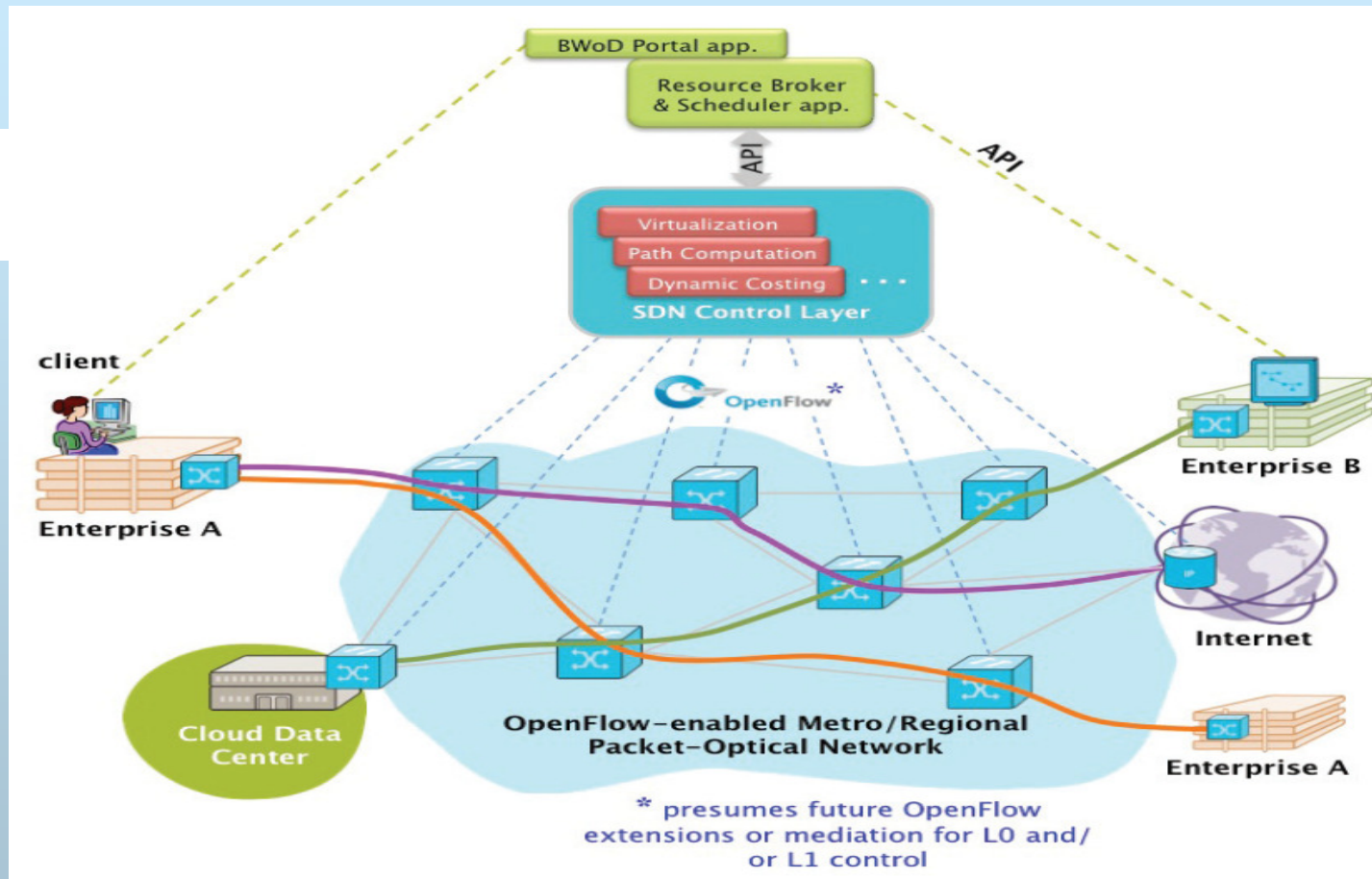

Source: *Operator Network Monetization Through OpenFlow-Enabled SDN*, ONF Solution Brief, April 3, 2013, <https://www.opennetworking.org/images/stories/downloads/sdn-resources/solution-briefs/sb-network-monetization.pdf>

NetWare 2013 Conference, August 25, 2013, Barcelona



CONTENTS



1. Software Defined Networks (Basics)
2. SDN Applications
3.  **SDN-OpenFlow**
4. SDN Extensions and Advanced Architectures
5. Other recent technologies- SDN approach
6. SDN-like architecture example : ALICANTE Project
7. Conclusions

- **Basic Flow table functionalities**
- *Source: OpenFlow Switch Specification, V 1.3.0 (Wire Protocol 0x04) June 25, 2012*

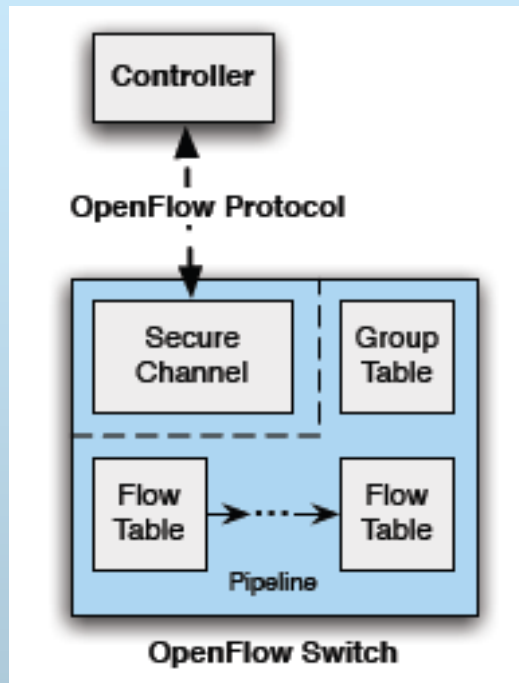

Figure 1: Main components of an OpenFlow switch

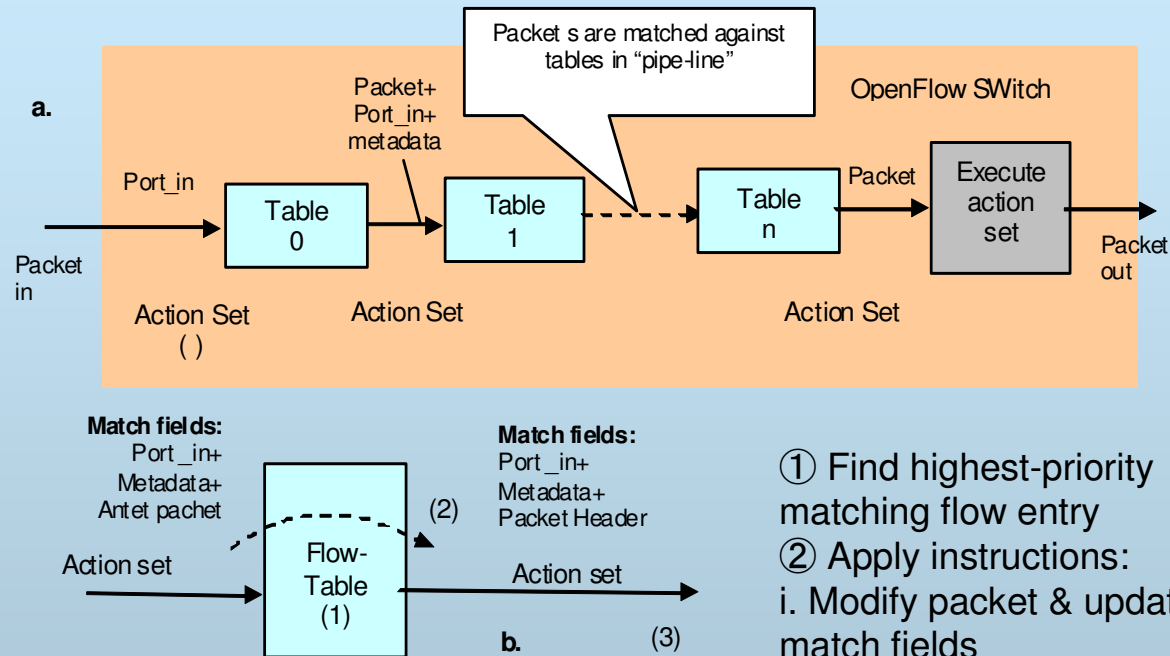

Figure 2: Packet flow through the processing pipeline.

- ① Find highest-priority matching flow entry
- ② Apply instructions:
 - i. Modify packet & update match fields (apply actions instruction)
 - ii. Update action set (clear actions and/or write actions instructions)
 - iii. Update metadata
- ③ Send match data and action set to next table



3. SDN-OpenFlow



OpenFlow

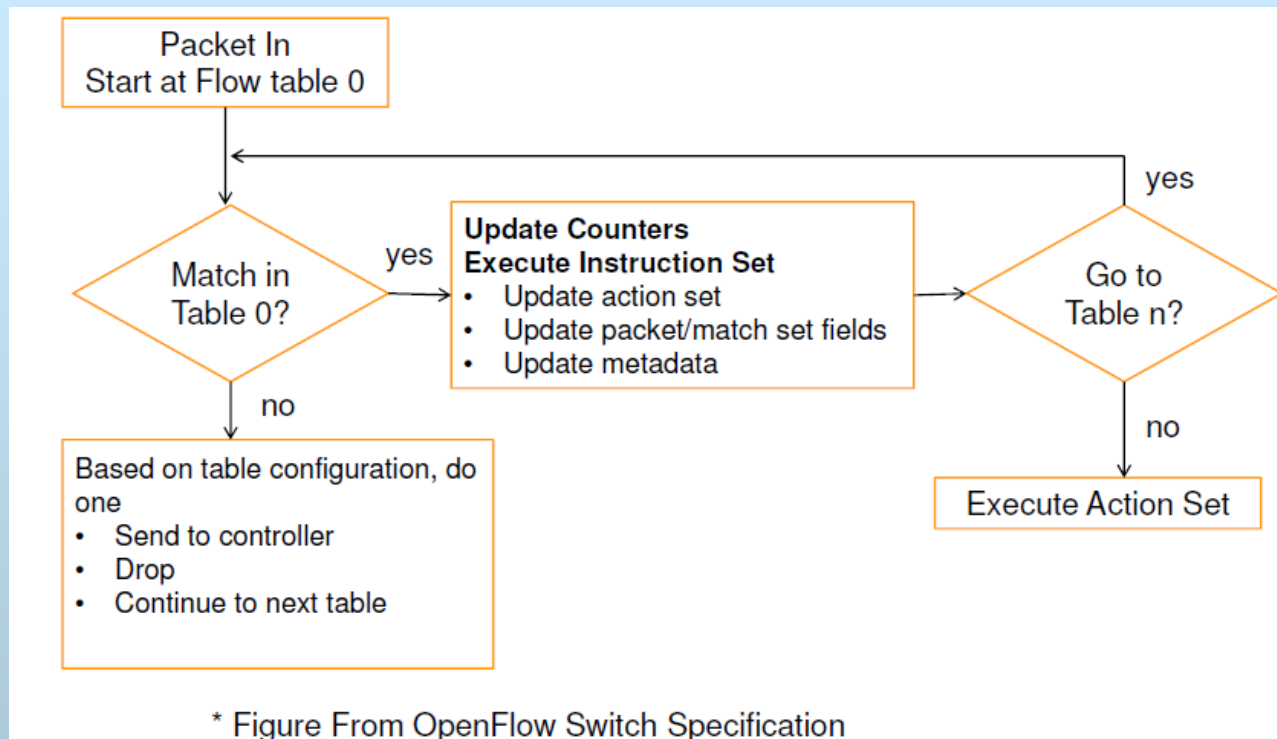



3. SDN-OpenFlow



- **OpenFlow**
- Available Software Switch Platforms
- SDN software switches
 - can be used to run a SDN testbed or when developing services over SDN.

Software Switch	Implementation	Overview	Version
Open vSwitch [14]	C/Python	Open source software switch that aims to implement a switch platform in virtualized server environments. Supports standard management interfaces and enables programmatic extension and control of the forwarding functions. Can be ported into ASIC switches.	v1.0
Pantou/OpenWRT [15]	C	Turns a commercial wireless router or Access Point into an OpenFlow-enabled switch.	v1.0
ofsoftswitch13 [11]	C/C++	OpenFlow 1.3 compatible user-space software switch implementation.	v1.3
Indigo [6]	C	Open source OpenFlow implementation that runs on physical switches and uses the hardware features of Ethernet switch ASICs to run OpenFlow.	v1.0

Current software switch examples compliant with the OpenFlow standard



3. SDN-OpenFlow



Examples of native SDN switches compliant with the OpenFlow standard

Provider	Switch Model	Version
HP	8200zl, 6600, 6200zl, v1.0 5400zl, and 3500/3500yl	v1.0
Brocade	NetIron CES 2000 Series	v1.0
IBM	RackSwitch G8264	v1.0
NEC	PF5240 PF5820	v1.0
Pronto	3290 and 3780	v1.0
Juniper	Junos MX-Series	v1.0
Pica8	P-3290, P-3295, P-3780 and P-3920	v1.2

Source [2]: M.Mendonca, et. al., A Survey of SDN: Past, Present, and Future of Programmable Networks http://hal.inria.fr/docs/00/83/50/14/PDF/bare_jrnl.pdf



3. SDN-OpenFlow



Controller Implementation Examples

Source: M. Mendonca, et al., A Survey of Software-Defined Networking: Past, Present, and Future of Programmable Networks http://hal.inria.fr/docs/00/83/50/14/PDF/bare_jrnl.pdf

Controller name	Implem.	Open Source	Developer	Characteristics
NOX	Python/C++	y	Nicira	General, first SDN controller
POX	Python	Y	Nicira	General
MUL	C	Y	Kulcloud	Multi-threaded infrastructure, multi-level north-bound I/F
Beacon	Java	Y	Stanford	Cross-platform, modular, event-based and threaded operation
Trema	Ruby/C	Y	NEC	Framework for developing OpenFlow Ctrl.
Maestro	Java	Y	Rice University	NOS, provide I/F to develop modular network control
Jaxon	Java	Y	Independent	Based on NOX
Floodlight	Java	Y	BigSwitch	Based on the Beacon; works with PHY/V OF switches.



3. SDN-OpenFlow



■ Controller Implementation Examples

Source: M. Mendonca, et al., *A Survey of Software-Defined Networking: Past, Present, and Future of Programmable Networks* http://hal.inria.fr/docs/00/83/50/14/PDF/bare_jrnl.pdf

Controller name	Implem.	Open Source	Developer	Characteristics
SNAC	C++	No	Nicira	Based on NOX; web-based, user-friendly policy manager: manage configure, monitoring
ovs-controller	C	Y	Independent	Simple OF ctrl. Ref. implem. with Open vSwitch ; manages any number of switches through the OF protocol;
Ryu	Python	Y	NTT, OSRG group	SDN OS ; provide logically centralized control and APIs to create new network M&C applications. Supports OpenFlow v1.0, v1.2, v1.3, and the Nicira Extensions.
NodeFlow	JavaScript	Yes	Independent	Written in JavaScript for Node.JS
Flowvisor	C	Y	Stanford/Nicira	Transparent proxy between OF switches and multiple OF controllers; can create network slices and delegate control of each slice to a different controller; isolation between slices.
RouteFlow	C++	Y	CPQD	Provide virtualized IP routing over OF capable hardware. It is composed by an OF Ctrl. Appl., an independent server, and a VNet environment reproducing the connectivity of a PHY infrastructure; it runs IP routing engines.



CONTENTS



1. Software Defined Networks (Basics)
2. SDN Applications
3. SDN – OpenFlow
4.  **SDN Extensions and Advanced Architectures**
5. Other recent technologies- SDN approach
6. SDN-like architecture example : ALICANTE Project
7. Conclusions



4. SDN Extensions and Advanced Architectures



- **SDN Scalability issues**

- **Why scalability-related questions”?**
 - **Reasons:**
 - centralized (more or less) control plane
 - signaling overhead (forwarders- controllers)
 - A single central controller will not scale for larger networks (no. of switches, flows, bandwidth, etc.)
 - E.g.NOX (the first SDN controller), can process max. 30,000 flow initiations per sec, [see NOX Refs] if less than 10 ms install time per flow is wanted
- Early SDN experiments and proposals have been flow-based → additional flow initiation delay .
- However, recent studies show that SDN scalability is manageable and does not raise more problems than traditional networking control plane design

- *Source[29]:S. H.Yeganeh, A.Tootoonchian, Y. Ganjali , On Scalability of Software-Defined Networking, IEEE Comm. Magazine, February 2013.*



4. SDN Extensions and Advanced Architectures



- **SDN Scalability issues**
- CPI/Dpl decoupling issues
 - need standard API between Cpl/DPI - to allow their independent evolutions - not so simple
 - switch manufacturers should adopt the same APIs (compatibility reasons)
 - moving control far away from switches/routers → may create signaling overhead (both directions)
- **Controller scalability**
 - a single controller will be for sure a bottleneck if the number of switches and flows increase
- ***Solution proposals examples:***
 - **Direct solution [30]:** increase the controller processing power (through better management, multicore processors)
 - *Source: A. Tootoonchian et al., “On Controller Performance in Software-Defined Networks,” Proc. USENIX Hot-ICE '12, 2012, pp. 10–10.*
 - (**DIFFANE [31]**) : Proactive pushing the states to the data paths
 - *Source: M. Yu et al., “Scalable Flow-Based Networking with DIFANE,” Proc. ACM SIGCOMM 2010 Conf., 2010, pp. 351–62.*



4. SDN Extensions and Advanced Architectures



- **SDN Scalability issues**
- **DevoFlow [32]: Dividing the flows in two classes** (to reduce the controller tasks)-
 - Short lived flows – handled in Data path only
 - Long lived/larger flows- forwarded to the controller
 - *Source: A. R. Curtis et al., “DevoFlow: Scaling Flow Management for High-Performance Networks,” Proc. ACM SIGCOMM ’11, 2011, pp. 254–65.*
- **Multiple controllers- solution for large networks**
 - **Several controllers (distributed DPI)**
 - However maintaining the unified view on the network (to benefit from SDN advantages)
 - Need to maintain consistency between them
 - Full/strong consistency is difficult to achieve (affects the control plane response time)
 - Define a convenient consistency level (while maintaining availability and partition tolerance)
 - The necessary degree of consistency between several controllers depends on the type of control applications
 - No standard protocols defined yet for communication/synchronization between controllers



4. SDN Extensions and Advanced Architectures



- SDN Scalability issues
- Examples:
- **Onix [33] :**
 - distributed control platform implementing a **distributed CPI**
 - It provides general APIs for control appl. to access network state (NIB), which is distributed over ONix instances.
 - *Source: T. Koponen et al., "Onix: A Distributed Control Platform for Large-Scale Production Networks," Proc. 9th USENIX, OSDI Conf., 2010,*
- **Kandoo [34]**
 - **distributed the control plane**
 - It defines a scope of operations → applications with different requirements can coexist:
 - **locally scoped applications** (they can operate using the switch local state) are deployed close to the data path and shield other parts of the control plane from the load
 - A root controller, maintains a network-wide state and coordinates local controllers.
 - *Source: S. H. Yeganeh and Y. Ganjali, "Kandoo: A Framework for Efficient and Scalable Offloading of Control Applications," Proc. HotSDN '12 Wksp., 2012*



4. SDN Extensions and Advanced Architectures



- **SDN Scalability issues**
 - **HyperFlow [35]**
 - multiple controller
 - it synchronizes network state among controller instances
 - the control applications (running on every controller instance) see a virtual single control over the whole network.
 - *Source: A. Tootoonchian et.al., "Hyperflow: A Distributed Control Plane for OpenFlow," Proc. 2010 INMConf., 2010.*
- **Flow processing issues**
- **Early SDN proposals :**
 - *Reactive style* of flow handling (i.e all flows are first processed in the controller) → high flexibility (fine-grained high-level network-wide policy enforcement) but it introduces a flow setup delay and limits the scalability.
- **Alternative solution:**
 - *Proactive style*- forwarding entries are set up before the initiation of actual flows can avoid the flow setup delay penalty altogether.



4. SDN Extensions and Advanced Architectures



- **SDN Scalability issues**
- **Other methods to improve scalability**
 - Placing the controllers in the proximity of the group of switches they control- may enhance the response time
 - Open issue: how to geo-distribute the controllers as to prepare upgrading of the network in different regions
- **Aggregation of rules:**
 - The control program may
 - define aggregate rules(i.e per classes like in DiffServ technology) matching a large number of micro-flows,
 - proactively install rules in the forwarders to provide E2E connectivity and identify quality of service (QoS) classes,
 - classification and reactive labeling flows may be performed at the edges



4. SDN Extensions and Advanced Architectures



■ Software Defined Internet Architecture

- SDN is a promise for enhancing the networking flexibility and performance
- Going further: define a flexible architecture “software defined”
- Recent proposal:
- **Main ideas:**
 - Make the architectural evolution more flexible through software
 - General comment: attempts to solve incrementally the Internet deficiencies, including “clean slate” ones – had limited success
 - By decoupling the architecture w.r.t infrastructure
 - Authors (*) claim that even after recent advances (including “clean slate- ICN/CCN, etc. and SDN) the *architecture* remained *coupled* with *infrastructure*
 - Architecture: IP protocols and packet handling rules
 - Infrastructure: PHY equipments
 - Coupling means that changes at IP level will need some changes in the routers (e.g. because lack of ASIC flexibility)
- (*) Source [36]: B. Raghavan, T. Koponen, A. Ghodsi, M. Casado, S. Ratnasamy, S. Shenker *Software-Defined Internet Architecture: Decoupling Architecture from Infrastructure, Hotnets '12, October 29–30, 2012, Seattle, WA, USA.*



4. SDN Extensions and Advanced Architectures



- **Software Defined Internet Architecture (cont'd)**
 - OpenFlow has increased the flexibility but still does not solve the decoupling;architecture/infrastructure
 - to support a wide range of architectures, the forwarders should support very general set of matching rules and fwd. actions.
 - Big header size, cost
- Proposal in (*) considers useful features of several technologies and tries combine them in an intelligent way as to realize that decoupling:
 - **MPLS** : (distinction :edge/core, partial separation DPI/CPI)
 - **SDN**: separation CPL/DPI, I/F through which the CPI can program the forwarders
 - **Middleboxes** (perform tasks beyond IP fwd.)
 - **SW forwarding** (based on fast processors)- the other extreme is ASIC based routers (highest ratio cost/perf)



4. SDN Extensions and Advanced Architectures



- **Software Defined Internet Architecture (cont'd)**
 - Data Plane (DPI) splitted in
 - Core network (its own addressing scheme)
 - Edge network
 - Architectural dependencies – placed at the edges
 - SW forwarding in the edge (assure flexibility)
 - Control Plane (CPI) uses SDN-like control to edge routers (can be OpenFlow- based but not mandatory)
 - Each core network domain has its own design
 - **The approach allows a top-down perspective**
 - Still SDN style of control is proposed
 - Openflow or equivalent is needed to be standardized
 - However – no need to specify beforehand the behavior of each box- because the controller assures interoperation



4. SDN Extensions and Advanced Architectures



- **Software Defined Internet Architecture (cont'd)**
- Top-down perspective
 - Tasks (to get E2E connectivity):
 - *Interdomain: Domain A-Domain B*
 - *intradomain transit*
 - *intradomain delivery (from domain edges to/from hosts or between hosts)*
 - *Main suggestion: separation between intradomain and interdomain addressing*
 - interdomain addressing :
 - some form of domain identifiers, to support interdomain task
 - no ref. to any intradomain addresses (each domain can choose its own internal addressing scheme)
 - this important choice can be solved in “clean-slate” style or some specific solutions can be applied (e.g. using the IPv6 flow ID as the interdomain Id.)
 - each domain is represented by a single logical server in the algorithm to compute interdomain routes
 - the server may be replicated for reliability, but a single logical entity represents the domain for interdomain routing algorithm
 - Routing alg.: BGP-like or *any other new algorithm*



4. SDN Extensions and Advanced Architectures



- **Software Defined Internet Architecture (cont'd)**
- Intradomain tasks: *edge-to-edge transit, edge-to-H delivery, and H-to-H delivery*
 - -implemented independently w.r.t. interdomain task
 - different domains can use different implementations for intradomain tasks (e.g MPLS)
 - the core can use *any internal fwd and control plane* (SDN.... traditional protocols)
 - each domain's core can use their own internal addressing scheme.
- The edge uses SW fwd.
 - commodity processors managed by an SDN edge controller
 - SDN edge controller knows the core requirements to insert the appropriate packet headers to achieve internal or edge delivery.
- Result: highly modularity



4. SDN Extensions and Advanced Architectures



- **Software Defined Internet Architecture (cont'd)**
 - **Advantages:**
 - Only the edge routers need to understand interdomain addressing
 - Core routers need to understand intradomain addressing in their domain only
 - Only the edge-controller participate in the interdomain route computation
 - Only the core Cpl needs to determine the internal routes
 - The only components needed to forward packets based on interdomain addresses are edge routers, which use software forwarding.
 - **Result: high architectural freedom**
 - Question: SW fwd- is it realistic in this context?
 - apparently yes , encouraging results []: longest-prefix match forwarding on minimum-sized packets, including checksum verification and TTL adjustment, can be done at 6.7Gbps on a single 3.3Ghz core.



4. SDN Extensions and Advanced Architectures



- **Software Defined Internet Architecture (cont'd)**
- **SDIA defines an Interdomain Service Model (ISM) [36]:**
 - only edge controllers (one per domain) are involved in interdomain task
 - and edge routers (controlled by the edge controller)
- **Implications:**
 - Interdomain routing changes (e.g. BGP to other) only involve changing SW in the edge controllers
 - Changing how domains are addressed → a change only to the controller SW
 - Changing how hosts are addressed, (e.g. IP to IPv6), is done per domain.
- **ISM in SDIA main requirements:**
 - A distributed interdomain algorithm between *the edge controllers* that computes whatever state the controllers need to implement the service model; (e.g. BGP)
 - A set of forwarding actions to be sent to the edge routers by the edge-controllers.
 - Allow incremental/partial deployment; need a basic unicast packet-delivery ISM (such as supplied by IP and BGP), so that non-peering domains can set up tunnels with each other
 - a discovery mechanism : domains participating in an ISM are aware of each other.

- Software Defined Internet Architecture (cont'd)
 - Illustration of the ISM principles

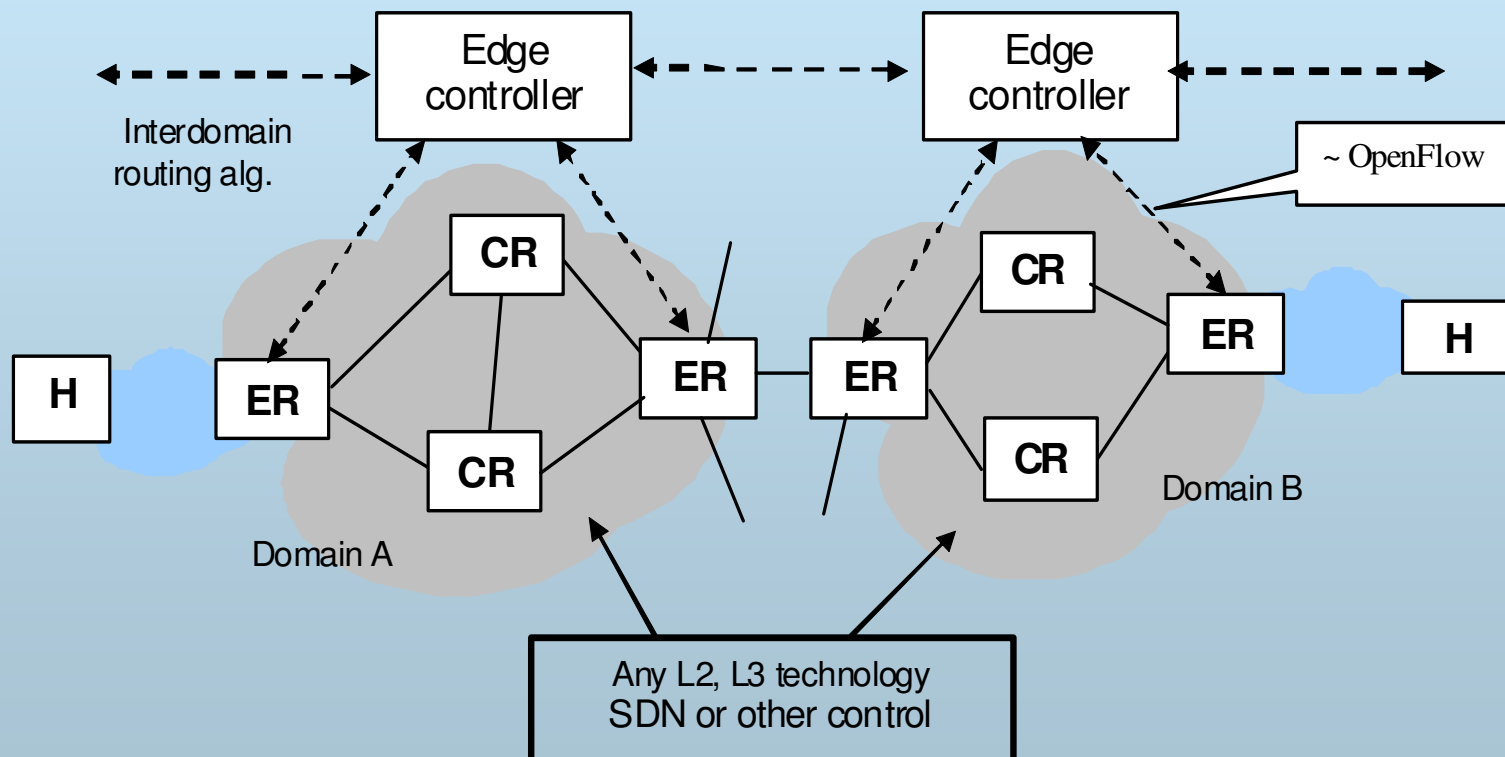



CONTENTS



1. Software Defined Networks (Basics)
2. SDN Applications
3. SDN – OpenFlow
4. SDN Extensions and Advanced Architectures
5. **👉 Other recent technologies- SDN approach**
6. SDN-like architecture example : ALICANTE Project
7. Conclusions

■ Cloud Computing summary

■ The NIST Definition of Cloud Computing (CC)

- (NIST: National Institute of Standards and Technology USA) [37,38]

- CC: a model for enabling ubiquitous, convenient, *on-demand* network access to a *shared pool of configurable computing resources* (e.g., networks, servers, storage, applications, and services)
- that can be *rapidly provisioned and released* with minimal management effort or service provider interaction.

- Cloud model : five essential characteristics , three service models, four deployment models.

■ Basic Cloud Characteristics [38]

- *On-demand self-service*
- *Broad network access*
- *Resource pooling*
- *Rapid elasticity.*
- *Measured service.*

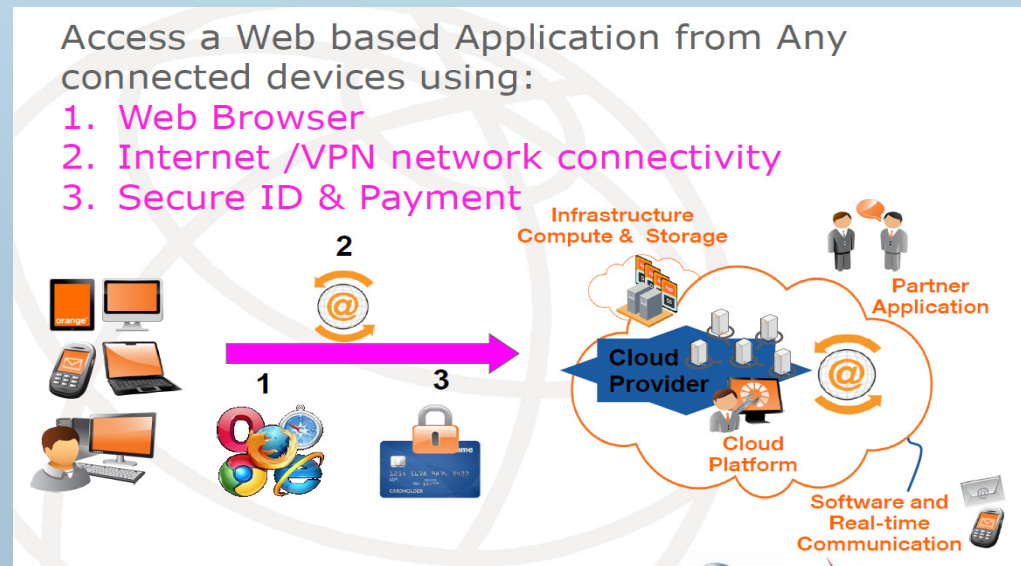



5. Other recent technologies - SDN approach



- Cloud Computing summary
- Service Models
 - **Software as a Service (SaaS)**
 - Consumer can use the **provider's applications running on a cloud**
 - Applications are accessible from client devices (thin client I/F, such as a *web browser* or a *program interface*.)
 - The consumer *does not manage or control the underlying cloud infrastructure* (network, servers, OS, storage, or even individual application capabilities)
 - possible exception : limited user-specific application configuration settings
 - **Platform as a Service (PaaS)**
 - Consumer
 - can deploy on the cloud infrastructure **consumer-created or acquired applications created using programming languages, libraries, services, and tools** supported by the provider
 - **does not** manage or control the *underlying cloud infrastructure* (network, servers, OS, storage)
 - but *has control over the deployed applications* and possibly configuration settings for the application-hosting environment
 - **Infrastructure as a Service (IaaS)**
 - Consumer
 - can **provision processing, storage, networks**, and other computing resources
 - *Can deploy and run arbitrary software*, (including OS and applications)
 - **does not** manage or control the underlying cloud infrastructure
 - but has control over OS, storage, and deployed applications
 - and possibly *limited control* of select networking components (e.g., host firewalls)



5. Other recent technologies - SDN approach



- **Cloud Computing summary**
 - **Deployment Models**
 - **Private cloud**
 - The *cloud infrastructure is provisioned for exclusive use by a single organization*
 - **Community cloud**
 - The cloud infrastructure is provisioned for exclusive use by a *specific community* of consumers from organizations that have *shared concerns* (e.g., mission, security requirements, policy, and compliance considerations).
 - **Public cloud**
 - The cloud infrastructure is provisioned for *open use by the general public*.
 - It may be owned, managed, and operated by a business, academic, or government organization, or some combination of them. It exists on the premises of the cloud provider.
 - **Hybrid cloud**
 - The cloud infrastructure is a *composition of two or more distinct cloud infrastructures* (private, community, or public) that remain unique entities

5. Other recent technologies - SDN approach

- Cloud Computing summary: NIST Reference architecture [38]

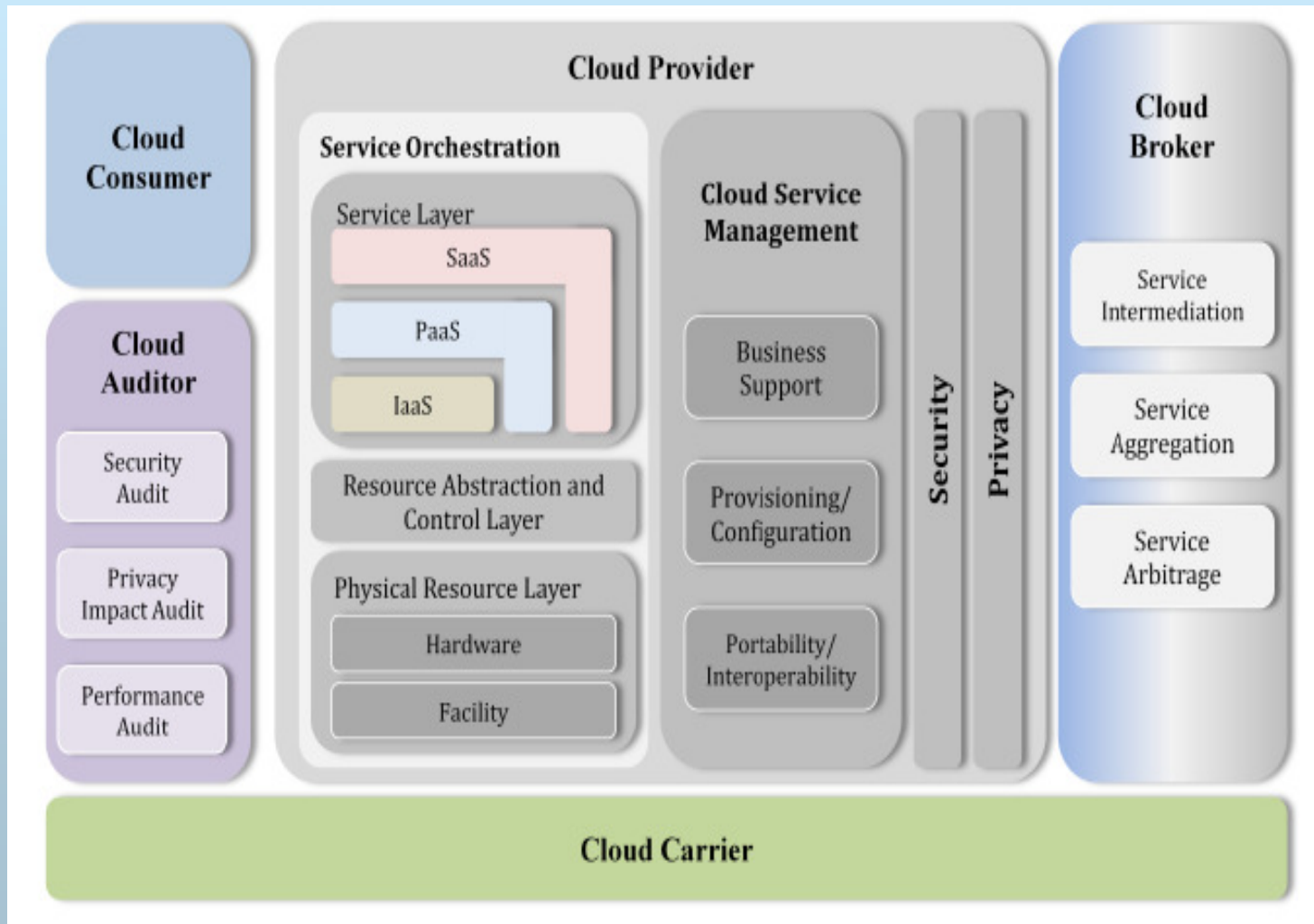



5. Other recent technologies - SDN approach



- Cloud Computing summary: NIST Reference architecture
 - Main actors

Actor	Definition
Cloud Consumer	A person or organization that maintains a business relationship with, and <i>uses service</i> from, <i>Cloud Providers</i> .
Cloud Provider	A person, organization, or entity responsible for <i>making a service available</i> to interested parties.
Cloud Auditor	A party that can conduct <i>independent assessment</i> of cloud services, information system operations, performance and security of the cloud implementation.
Cloud Broker	An entity that <i>manages the use, performance and delivery of cloud services, and negotiates relationships</i> between <i>Cloud Providers</i> and <i>Cloud Consumers</i> .
Cloud Carrier	An <i>intermediary</i> that provides <i>connectivity and transport of cloud services</i> from <i>Cloud Providers</i> to <i>Cloud Consumers</i> .



5. Other recent technologies - SDN approach



- **Cloud Computing summary**
- ITU-T position on Cloud Computing [40, 41] :
 - *Source: ITU-T Focus Group on Cloud Computing Technical Report (2012)*
 - **Cloud Eco-system**
 - **Cloud Service Provider (CSP)** An organization that provides and maintains delivered cloud services
 - **Cloud Service User (CSU)** A person or organization that consumes delivered cloud services
 - Consumer, Enterprise (including enterprise administrator), Governmental/public institution
 - **Cloud Service Partner (CSN)** A person or organization that provides support to the building of the service offer of a cloud service provider (e.g. service integration).
 - Application developer, Content provider, Software provider, Hardware provider,
 - Equipment provider, System integrator, Auditor



5. Other recent technologies - SDN approach



- **Cloud Computing summary**
- ITU-T position on Cloud Computing:
 - **New types of Cloud Services defined by ITU-T**
 - ***Communication as a Service - CaaS*** : real-time communication and collaboration services
 - audio/video communication services (VoIP, A/VC), collaborative services, unified communications, e-mail, instant messaging, data sharing (web conference)
 - ***Network as a Service – NaaS*** : transport connectivity services and/or inter-cloud network connectivity services.
 - **Managed Internet** (guaranteed speed , availability, etc.) virtualized networks (VPNs), coupled with cloud computing services, flexible and on demand bandwidth



5. Other recent technologies - SDN approach



- **Cloud Computing summary**
- ITU-T position on Cloud Computing:

Business roles versus Actors	Application CSP	Platform CSP	Infrastructure CSP	Cloud Service Partners	Cloud Service Users	Inter-cloud
Telecom SP	X	X	X	X	(X)	X
Internet SP	X	X	X	(X)	(X)	X
3 rd Party Provider	(X)	(X)	(X)	X	(X)	
User					X	

ITU-T
Actors of a Cloud Ecosystem

Possible roles in cloud scenario

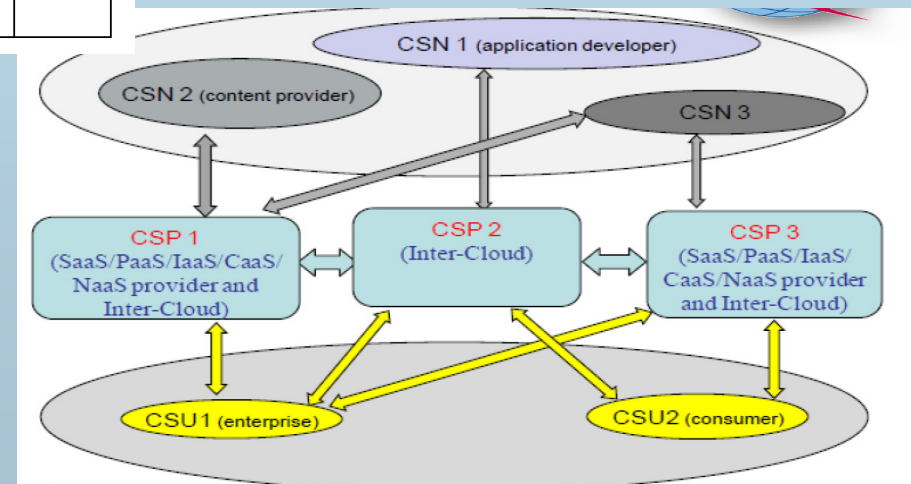



5. Other recent technologies - SDN approach



- **SDN in Cloud technology?**
 - SDN: Admin can change dynamically network switch's rules - prioritizing, de-prioritizing or even blocking specific types of packets (granular level of control)
 - This is helpful in a **cloud computing multi-tenant architecture**
 - administrator can manage traffic loads in a flexible and more efficient manner
 - **Some key requirements for IaaS “cloud networking”/SDN:**
 - Multi-tenancy
 - L2, L3 isolation
 - Scalable control plane
 - NAT (floating IP)
 - ACLs and Stateful (L4) firewall
 - VPN
 - BGP gateway
 - RESTful API
 - Integration with CMS (like OpenStack)



5. Other recent technologies - SDN approach



- **Example: Bandwidth Exchange service**
- Useful for Cloud Carriers also but more general
- **Problem:** the sourcing of raw bandwidth to deliver networking services is a constant challenge for *Network Operators (NO) and Virtual Network Operators (VNOs)*.
 - - need to avoiding excessive idle inventory.
- *Predictive business models* are used to evaluate bandwidth requirements on existing and future extensions of their networks.
- **Models usage:**
 - VNOs determine when and where to *lease* wholesale capacity.
 - NO drive their “*buy/build versus lease*” decisions:
 - *buy* decisions involve CAPEX/OPEX but provide operators with the greatest control over their network infrastructure
 - bandwidth *lease* decisions may make sense where capacity does not warrant dedicated builds or is not expected to grow substantially over time.



5. Other recent technologies - SDN approach



- **Bandwidth Exchange service**
- **However, planning and forecasting are by nature imperfect.**
 - The amount, timing, and location of bandwidth demands are difficult to predict, leading to network segments or links with either excessive or insufficient capacity.
 - **Lengthy lead times from equipment suppliers** or traditional wholesale bandwidth providers can exacerbate the issue,
- **Idle bandwidth (not generating revenue)** is undesirable, but also the ability to competitively/rapidly respond to new opportunities is needed for NO
- **Bandwidth exchange marketplaces** : alternative means for NO to address capacity planning challenges.
 - bandwidth suppliers and buyers can trade bandwidth like a commodity (with options and futures), and provide a means **to transfer the control of real bandwidth resources** between parties.
 - facilitate a common inventory of bandwidth contracts that can be priced and exchanged in an automated fashion.



5. Other recent technologies - SDN approach



- **Bandwidth Exchange service**

- **Bandwidth exchange markets provide other benefits:**
 - Quicker ROI from projects requiring capacity expansion
 - Reduced operational costs ← automation of bandwidth acquisition and provisioning
 - Optimized network expansion costs associated with “leased” bandwidth, taking advantage of general market pricing efficiency and elasticity

- **Bandwidth exchange markets challenges/needs:**
 - **Registration, tracking, and mgmt.** of available time-based bandwidth inventory across multiple network domains
 - **Secure and automated orchestration, scheduling, coordination, and provisioning** of resources between multiple supply and demand entities
 - **Integration of network operators’ management** systems into the bandwidth exchange BSS/OSS
 - **Policy management and admin.** of bandwidth resources according to parameters such as time, duration, volume, and location
 - **Monitoring and enforcement** of standardized SLAs across the market



5. Other recent technologies - SDN approach



- **Bandwidth Exchange service**
- **Next Figure** illustrates the concept of bandwidth exchange markets and a *reference implementation architecture*.
- **Suppliers and buyers meet at common, neutral exchange “points”** where bandwidth transactions can occur, such as for carrier Ethernet or optical transport bandwidth.
- **Examples**
 - Enterprise companies, may utilize the bandwidth exchange to acquire the most cost-effective leased bandwidth service to **Cloud Provider A** for a transaction-oriented cloud operation.
 - **Operator A** may use the bandwidth exchange to locate cost-effective bandwidth to interconnect two of its disjoint networks.
 - Diverse bandwidth requirements could be met by leasing bandwidth from different exchange points over different suppliers’ networks (**Operator B and Bandwidth Provider C**).

- Bandwidth Exchange

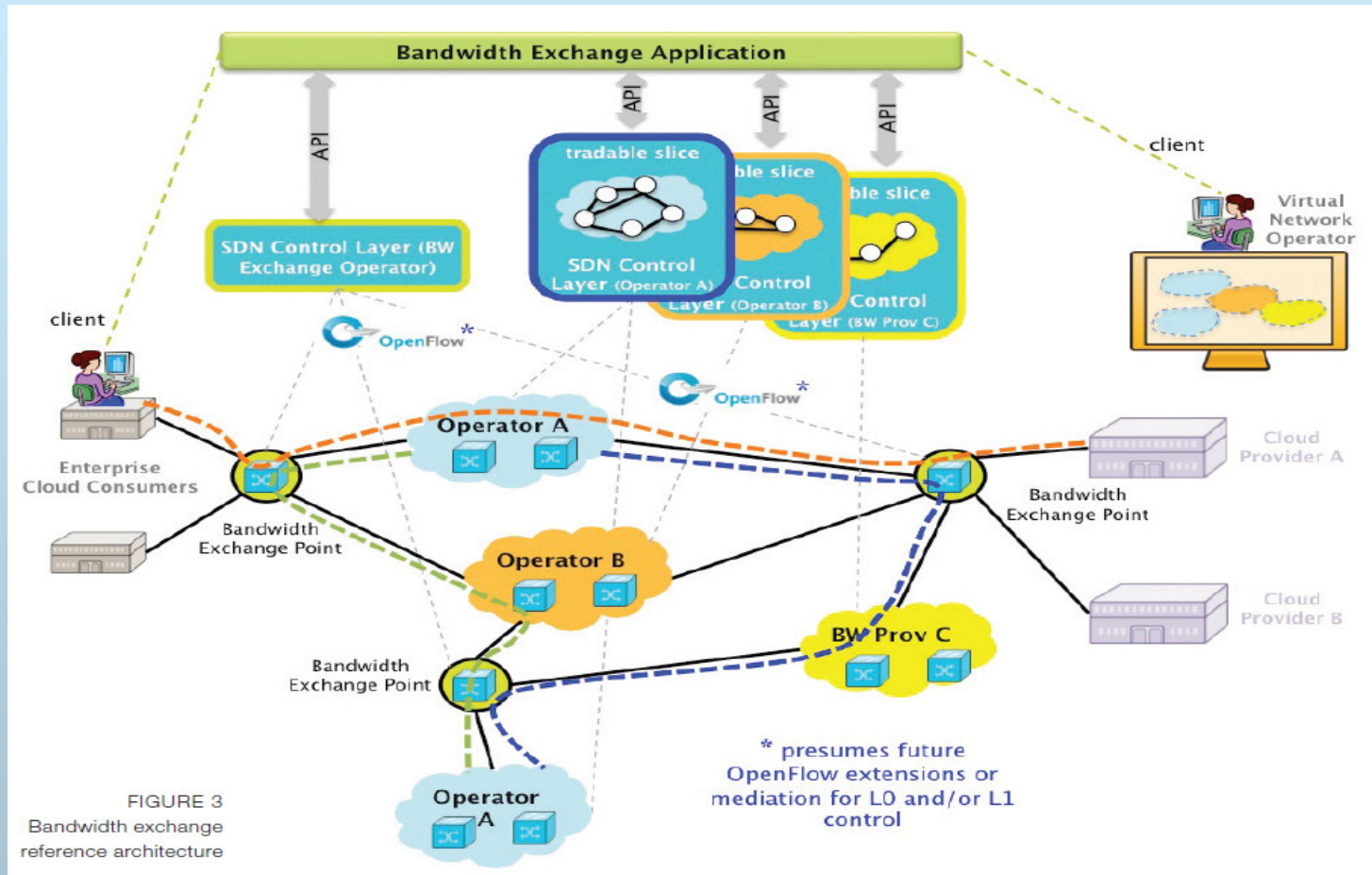

FIGURE 3
Bandwidth exchange
reference architecture

Source: *Operator Network Monetization Through OpenFlow-Enabled SDN, ONF Solution Brief, April 3, 2013, <https://www.opennetworking.org/images/stories/downloads/sdn-resources/solution-briefs/sb-network-monetization.pdf>*



5. Other recent technologies - SDN approach



- **Bandwidth Exchange service**
- ***SDN –OF provides essential tools for enabling automation*** of the processes necessary to achieve real-time bandwidth trading.
 - It can play a key role in supplier networks as well as in the bandwidth exchange market.
 - With bandwidth resources spanning multiple networks, *canonical abstractions* of available network services and bandwidth resources across multivendor environments are essential.
- ***SDN directly controls elements of the network architecture***
 - provisioning the bandwidth exchange point switches interconnecting these networks
 - slicing and dynamically allocating bandwidth in the supplier's network.
- **Standardized representation** and configurability of bandwidth flows **are essential** for enabling a bandwidth exchange marketplace to uniformly manage bandwidth inventory and provision flows in a multitenant environment.



5. Other recent technologies - SDN approach



- **Bandwidth Exchange service**

- **Conclusion on SDN approach**
 - allows bandwidth suppliers **to partition their networks** into “public/tradable” and “private/non-tradable” network slices.

 - provide **secure access and control** of their designated tradable bandwidth to the bandwidth exchange application, where their bandwidth can be pooled with tradable resources from other suppliers

 - the **matching of demand with supply**, based on duration and temporal availability, can be achieved through the logically centralized SDN control layer’s global perspective.

 - The **open API and Open Flow I/Fs facilitate the rapid, on-demand provisioning** of resources and the automation of workflow processes



5. Other recent technologies - SDN approach



■ ICN/CON/CCN- versus SDN

- recent attention : research /industry / operators
- propose some fundamental changes for TCP/IP networking
 - claiming several advantages in the perspective of Future Internet
- **Still open questions:**
 - what significant benefits does ICN designs offer?
 - are ICN designs the best solution to achieve those benefits?
 - Is the current technology prepared to introduce soon these changes?
 - Seamless development?
- **Terminology**
 - Not standardised, different (overlapping) semantics...
 - **ICN/CCN - Information/Content Centric Networking**
 - **CON - Content Oriented Networking**
 - **DON - Data Oriented Networking**
 - **CAN - Content Aware Networking**
 - **NDN - Named Data Networking**
- **Examples of ICN/CON Projects**
 - EUROPE : PSIRP, 4WARD, PURSUIT, SAIL, ...
 - USA: CCN , DONA , NDN, CCNx, ...



5. Other recent technologies - SDN approach



- **ICN/CON/CCN- versus SDN**

- The content-oriented paradigm: *content-oriented, content centric, content-based, data-oriented, or data-centric network* are considered to be equivalent in that they focus on not the communication party but the content or data itself

- **However**
 - there is little common terminology between different ICN/CON/CCN, ...proposals
 - no common framework → the focus is often on low-level mechanisms
 - many studies accentuate the differences between their design and others
 - they do not clarify enough the construction of the ICN assembly

- *Source[46]: A.Ghodsi, T.Koponen, B.Raghavan, S.Shenker, A.Singla, J.Wilcox, Information-Centric Networking: Seeing the Forest for the Trees, <http://www.icsi.berkeley.edu/~barath/papers/icn-hotnets11.pdf>*



5. Other recent technologies - SDN approach



■ ICN

- Infrastructure providing **in-network caching**
- Content is distributed in a scalable, cost-efficient & secure manner
- **Receiver-driven** model – subscribe/get objects of interest
- Support for location transparency, mobility & intermittent connectivity
- Still need to support interactivity (A/V) and location oriented services (e.g. similar service as telnet)
 - *Source [48]: G. Pavlou, Information-Centric Networking: Overview, Current State and Key Challenges, IEEE ISCC 2011 Keynote, <http://www.ee.ucl.ac.uk/~gpavlou/>*
- **ICN:**
- the principal paradigm is **not E2E** communication between hosts
- high amount of content need efficient distribution
 - **information objects as a first-class abstraction;**
 - **focusing on the properties of such objects** and receivers' interests to achieve efficient and reliable distribution of such objects
 - **In-network storage, multiparty communication** through replication, and interaction
 - **publish-subscribe** models generally available for all kinds of applications,
 - **No more need of dedicated systems** such as peer-to-peer overlays and proprietary CDNs
 - *Source[53]: D. Kutscher, B.Ahlgren, H.Karl, B. Ohlman, S.Oueslati I.Solis, Information-Centric Networking— Dagstuhl Seminar — 2011*



5. Other recent technologies - SDN approach



■ CON

- **Decoupling contents from hosts** (or their locations) not at the application but at the network level
- Hope to solve or mitigate also other Internet problems (mobility, security).
- Free application/service developers from reinventing application-specific delivery mechanisms
- Scalable and efficient delivery of requested contents (e.g., by supporting multicast/ broadcast/anycast)
 - CON: dealing with *content objects*: **naming, locating/routing, deliver/disseminate, caching in-network**
 - CON ~ ICN~CCN
 - *Source [43]: J. Choi, J. Han, E.Cho, T.Kwon, and Y.Choi “A Survey on Content-Oriented Networking for Efficient Content Delivery”IEEE Communications Magazine, March 2011pp. 121- 127*

■ CCN

- **CCN treats content as a primitive** – decoupling location from identity, security and access, and retrieving content by name
- New approaches to routing named content,
- derived from IP, one can achieve scalability, security and performance
 - *[50] Van Jacobson, D.K. Smetters, J.D. Thornton, M. F. Plass, NH. Briggs, R.L. Braynard, Networking Named Content, Palo Alto Research Center, Palo Alto, CA, October 2009*

■ CAN-NAA

- Content awareness at network level and content oriented processing
- Network awareness at service / application layer



5. Other recent technologies - SDN approach



- **Content-oriented concepts**
 - CON node : **routing by content names**, not by (host) locators
 - *hosts Identification* is replaced by *content identification*.
 - content file location - independent of its name
 - *content naming and routing – independent of location*
 - free from mobility and multi-homing problems
 - **Publish/subscribe (P/S)** communication model
 - Essential in CON:
 - A content source announces (or *publishes*) a content file
 - An user requests (or *subscribes* to) the content file.
 - P/S
 - **decouples the content generation and consumption** in time and space
 - so contents are delivered efficiently and scalably (e.g., multicast/anycast)
 - *Source [43]: J.Choi, Jinyoung Han, E.Cho, Ted Kwon, and Y.Choi, A Survey on Content-Oriented Networking for Efficient Content Delivery, IEEE Communications Magazine • March 2011*



5. Other recent technologies - SDN approach



■ ICN/CON/CCN- versus SDN

- ICN: information objects names are unique and independent of locations, applications, storages and distribution → allows ubiquitous information retrieval.
- **Typical ICN architectures/deployments**
 - 1. ICN over IP (encapsulate ICN protocol data in IP or UDP/TCP packets or take ICN protocol information using IP options;
 - 2. ICN over L2, (completely replace IP layer and L2 protocols (Ethernet, IEEE 802.x)
 - 3. ICN over virtualized network (exploit network virtualization technologies, e.g. SDN)
- The *draft-icn-implementation-sdn-00* – **proposes a unified framework based on SDN concepts**
 - *Source: W. Liu, J. Ren, J. Wang, draft-icn-implementation-sdn-00, „A Unified Framework for Software-Defined Information-Centric Network” August 09, 2013*



5. Other recent technologies - SDN approach



Example of CCN stack

CCN : new “thin waist” of the Internet: IP → to chunks of named content

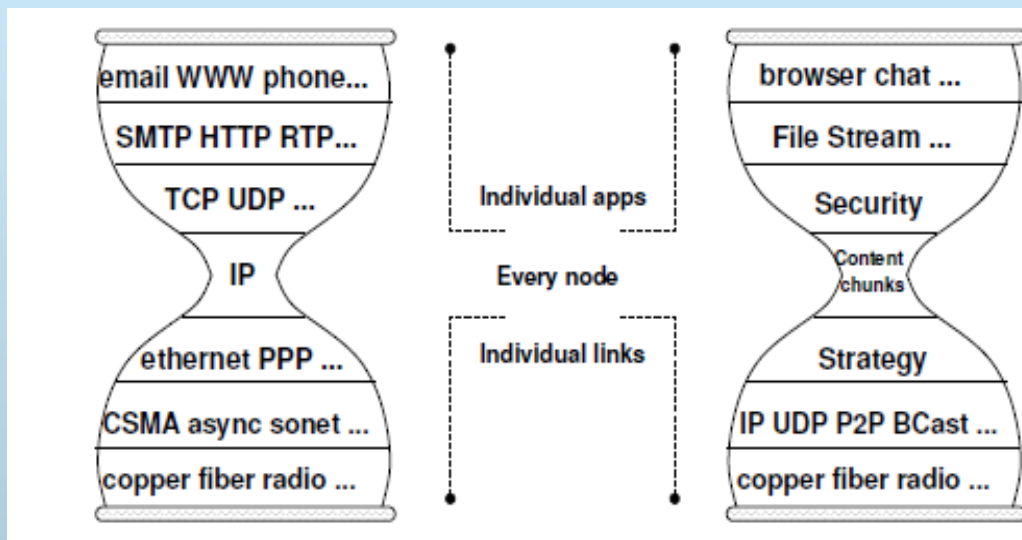

Traditional
TCP/IP stack



Original
picture
CCN

Source [50]: Van Jacobson Diana K. Smetters James D. Thornton Michael F. Plass, Nicholas H. Briggs Rebecca L. Braynard, Networking Named Content, Palo Alto Research Center, Palo Alto, CA, October 2009

Application	Applications: browser chat, file stream:
	Security
	Content chunks
	Strategy
TCP, UDP, ...	P2P, .. UDP
IP	Intra-domain routing: OSPF, .. Inter-domain routing: BGP, ... (placed here to show their role)
Data link	Any Layer 2
Physical Layer (wireline, wireless)	Any PHY

Alternative view of CCN stack
(if it runs on top of IP)



5. Other recent technologies - SDN approach



- Unified ICN-SDN framework**
 - Source [42] Lin et.al, : draft-icn-implementation-sdn-00, „A Unified Framework for Software-Defined Information-Centric Network” August 09, 2013

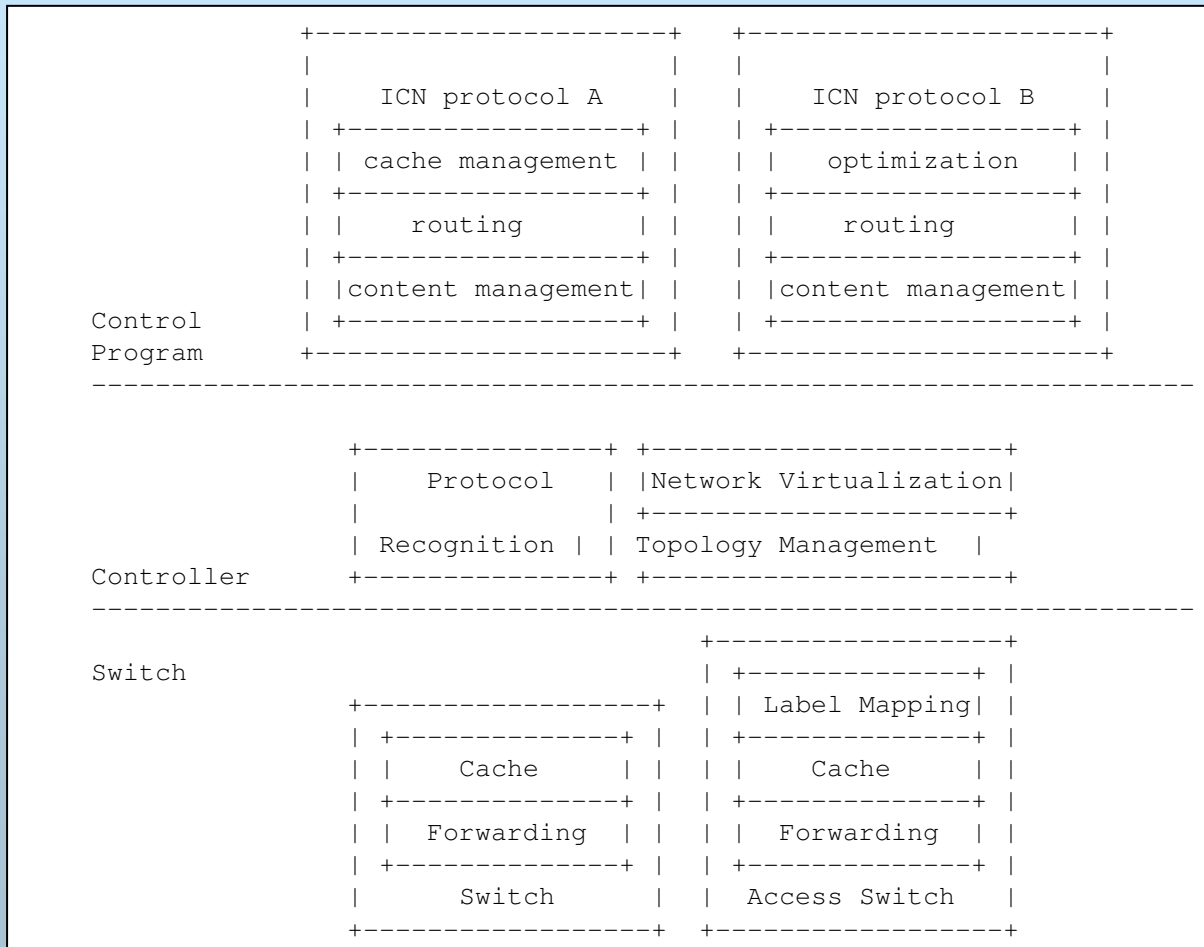



CONTENTS



1. Software Defined Networks (Basics)
2. SDN Applications
3. SDN-OpenFlow
4. SDN Extensions and Advanced Architectures
5. Other recent technologies- SDN approach
6.  **SDN-like architecture example : ALICANTE Project**
7. Conclusions



6. ALICANTE Project



- **ALICANTE**, 2010-2013, FP7 Integrated Project (IP):
MediA Ecosystem Deployment Through Ubiquitous
Content-Aware Network Environment- *Future Internet
oriented project*
- *<http://www.ict-alicante.eu/>*
- *19 European partners*
 - *Industry, SME*
 - *Operators*
 - *Universities*
 - *Research groups*



6. ALICANTE Project



- **Research Area: Networked Media**
 - **Content Aware Networking (CAN) & Network Aware Application (NAA)**
 - **Evolutionary architecture** for networked media systems
 - Mid-way between traditional Internet solutions and full ICN
 - However the architecture was not intentionally to be full SDN
- **ALICANTE general objectives:**
 - **End users**
 - Flexible access to MM services, consume, share, generate A/V content
 - **Providers** (high level services, connectivity services)
 - extend their services range for large number of users
 - efficiently manage their services and /or resources
 - Flexible cooperation between actors
 - Media services and network resources management in multi-domain, multi-provider environment
- **Novel virtual CAN) layer**
 - Content-Awareness delivered to Network Environment
 - Network- and User Context-Awareness to Service Environment
 - Different levels of QoS/QoE, security, etc. for media-oriented services
- **This presentation :**
 - Shows similarities between ALICANTE architecture and SDN

- **ALICANTE-** High level architectural view

- **Environments:**
- *User (UE)* : End-Users terminals
- *Service (SE)*: Service and Content Providers
- *Network (NE)*, CAN Providers, Network Providers

“*Environment* “: groups of functions defined around the same functional goal and possibly spanning, vertically, one or more several architectural (sub-) layers.

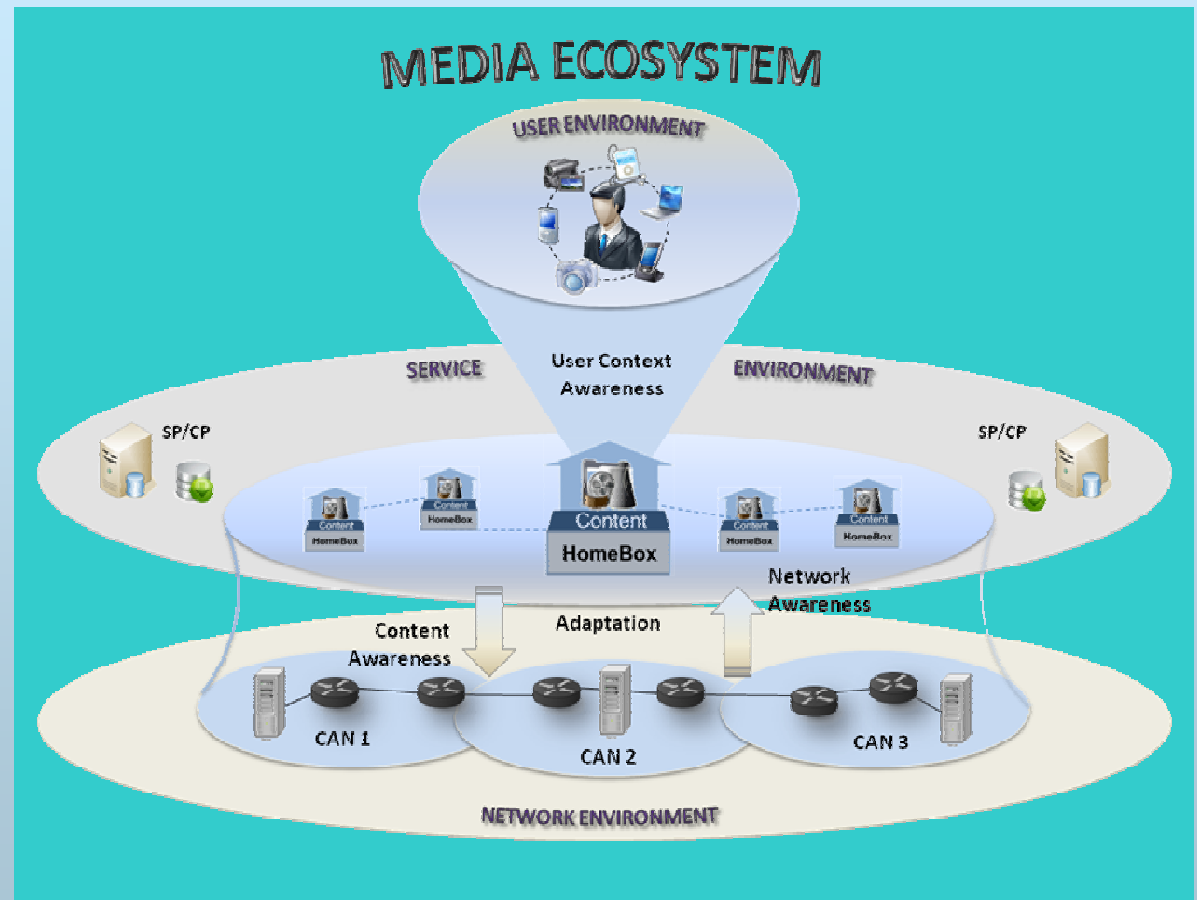

Business Model

Business Actors:

- End-User (EU)
- Content Provider (CP)
- Service Provider (SP)
- Network Provider (NP)
- CAN Provider (CANP) (new)

Flexible Business Model : B2C, B2B, C2C and to consider new CAN features and service environment new capabilities

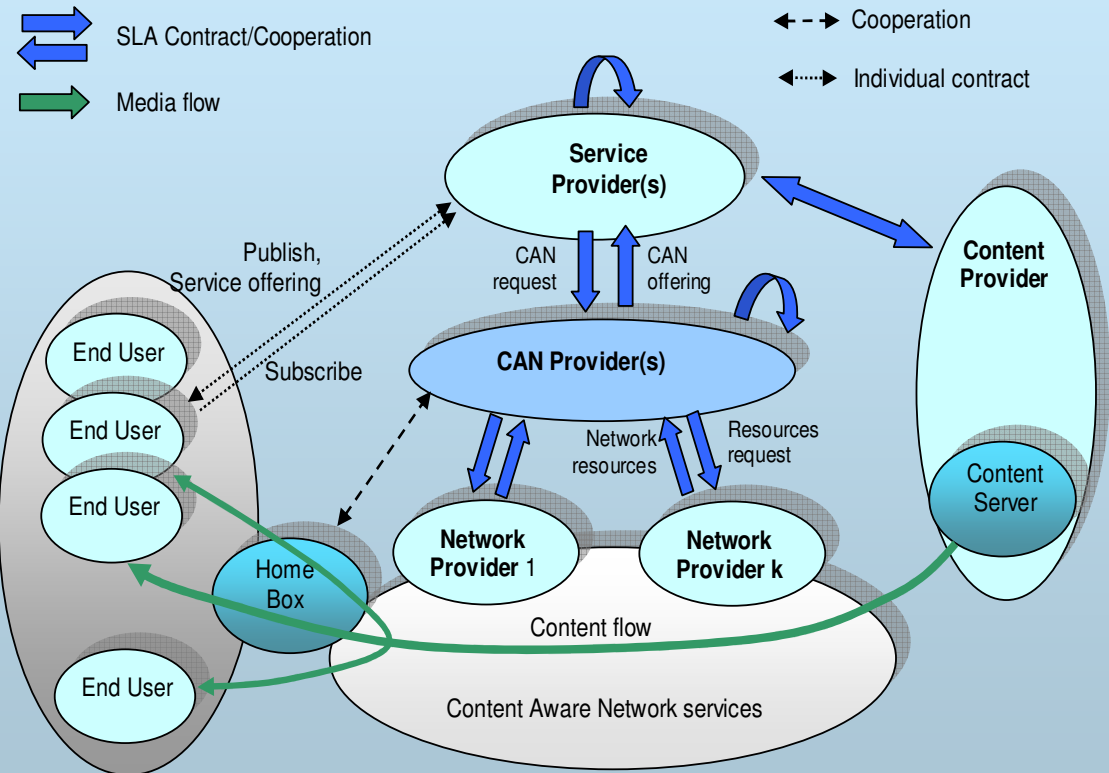

Cooperation, interaction:

- Single/aggregated roles of SP, CP, NP, ANP, C/SCs,
- Cooperation, via static and/or dynamic SLAs
- Distributed management
- Independent resource management for each actors

Services: Fully Managed (FM)

Partially managed (PM)

Unmanaged (UM)

Services requirements: established by SLAs, or:
CANP has some freedom to perform
autonomic actions



6. ALICANTE Project



- ALICANTE architecture
- Two virtual layers,
 - CAN layer for virtual connectivity services on top of the the core IP network
 - Combine resource provisioning at CAN layer with per/flow adaptation solution for the multimedia flow delivery over multi-domains
 - On top of the traditional IP Network layer, virtualising the network nodes
 - Home-Box layer- content delivery
- User Environment: interaction of End Users with the underlying layers
- Service Environment: cooperation between SPs and End-Users (through their HBs)
- Hierarchical Multi-layered monitoring sub-system at all levels: User, Service, Home-Box, CAN, Underlying network



6. ALICANTE Project



- **ALICANTE Architecture**
- *mid-way architecture* : CAN/NAA logical coupling, extendable both at service level and network/ transport level
- support integration
 - *vertical* (based on CAN/NAA) of high level services and connectivity ones,
 - *horizontal integration* on top of single or multiple-domain IP networks.
- network virtualization techniques is applied
 - to create parallel *content-aware virtual planes*
 - enriched in terms of functionality (due to content –awareness)
 - represented by *Virtual Content Aware Networks (VCANs)*
 - *Constrained routing and forwarding depending on content type*
 - VCANs spanning single or multiple IP domains
 - **Note: ALICANTE current architecture does not offer full network virtualization, but only in the Data Plane**



6. ALICANTE Project



Overall Architecture View (1)

- User Env
- Service Env
- HB-layer
- Net Env
 - CAN layer
 - Infrastructure layer

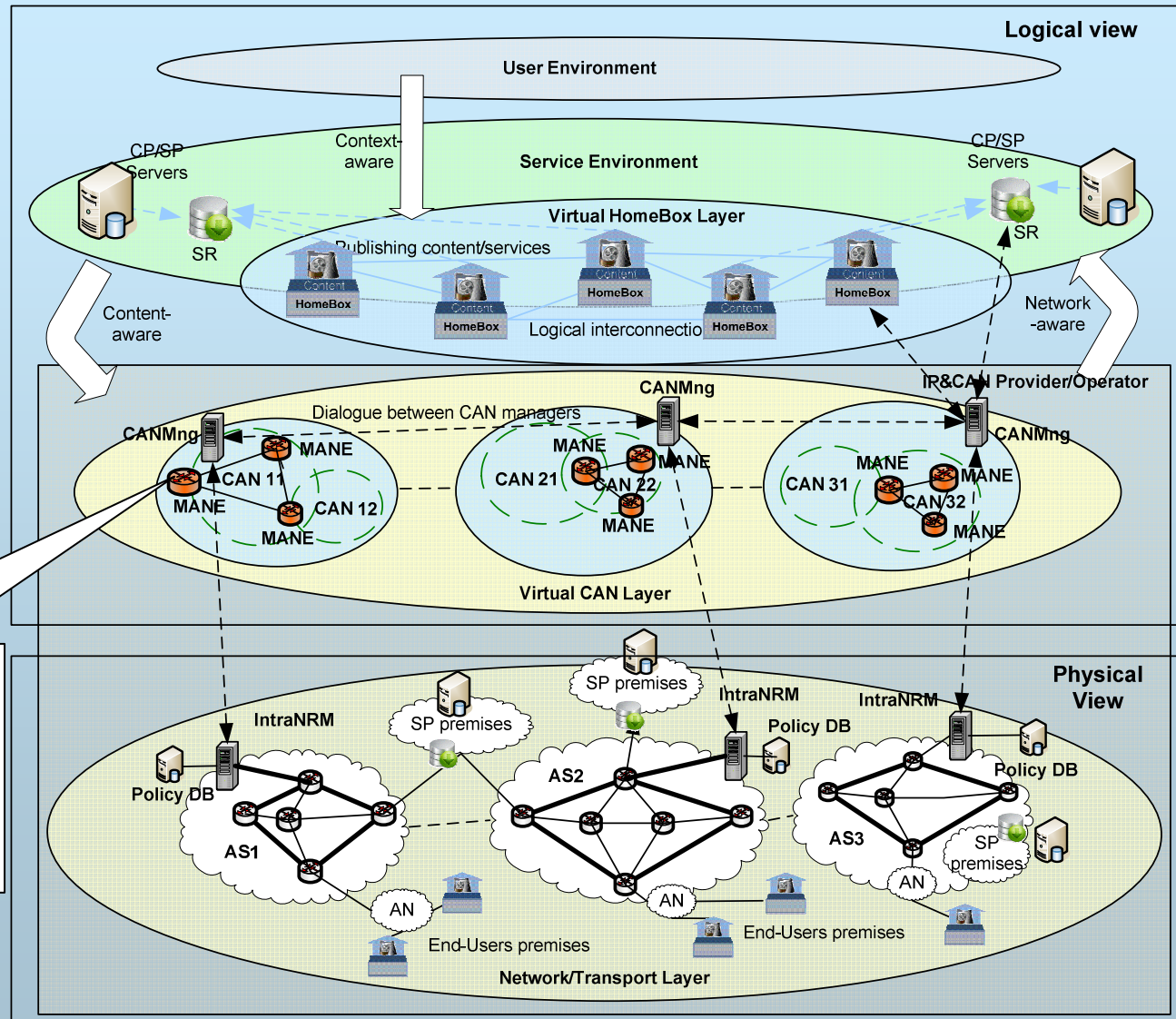

MANE –
Novel ALICANTE
router-
Media Aware
Network Element



6. ALICANTE Project



Functional Architecture partial view (2)

1,2,3,4 : Management/control Plane actions to install a VCAN in the network

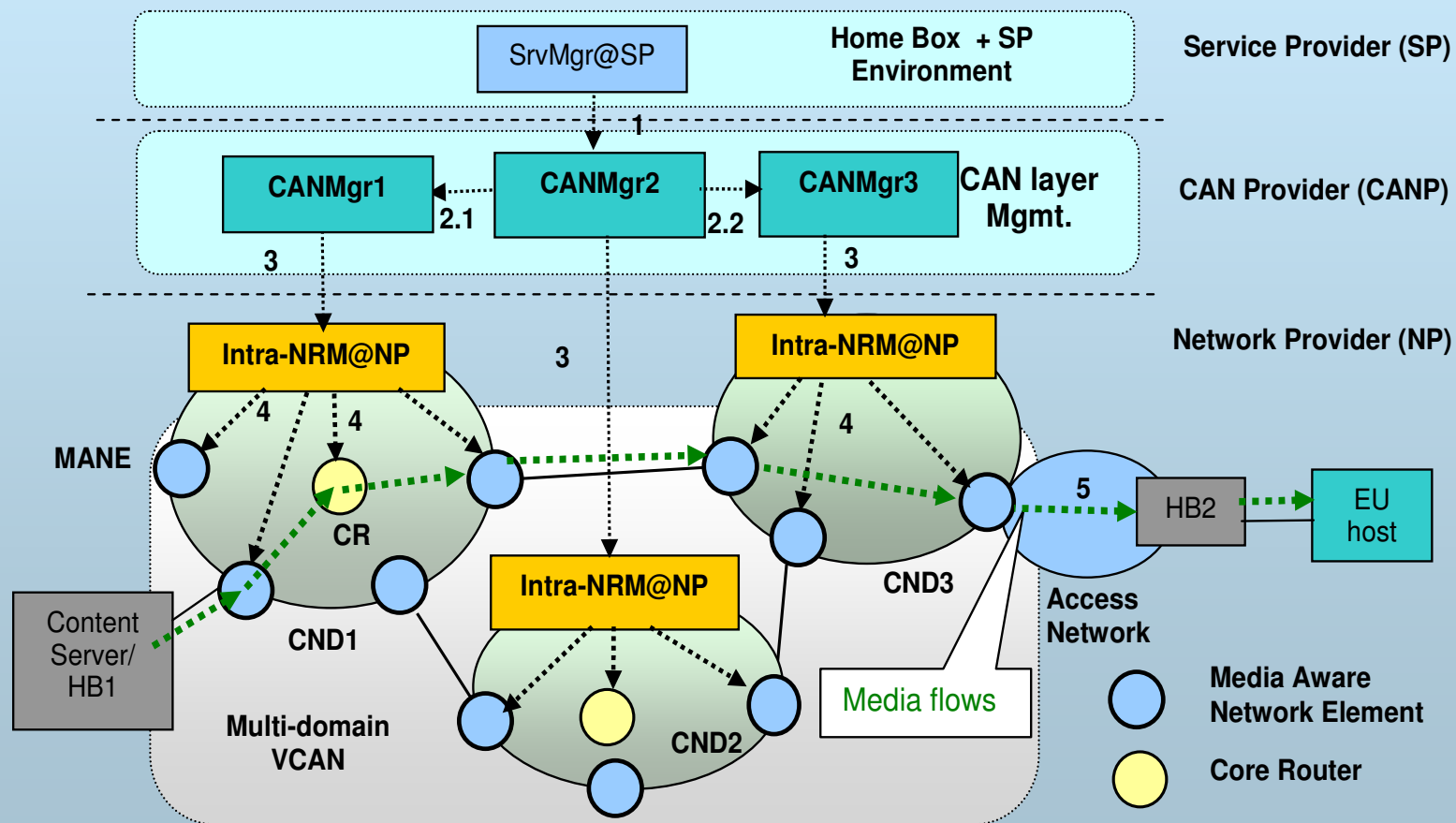

ALICANTE Architecture- SDN mapping

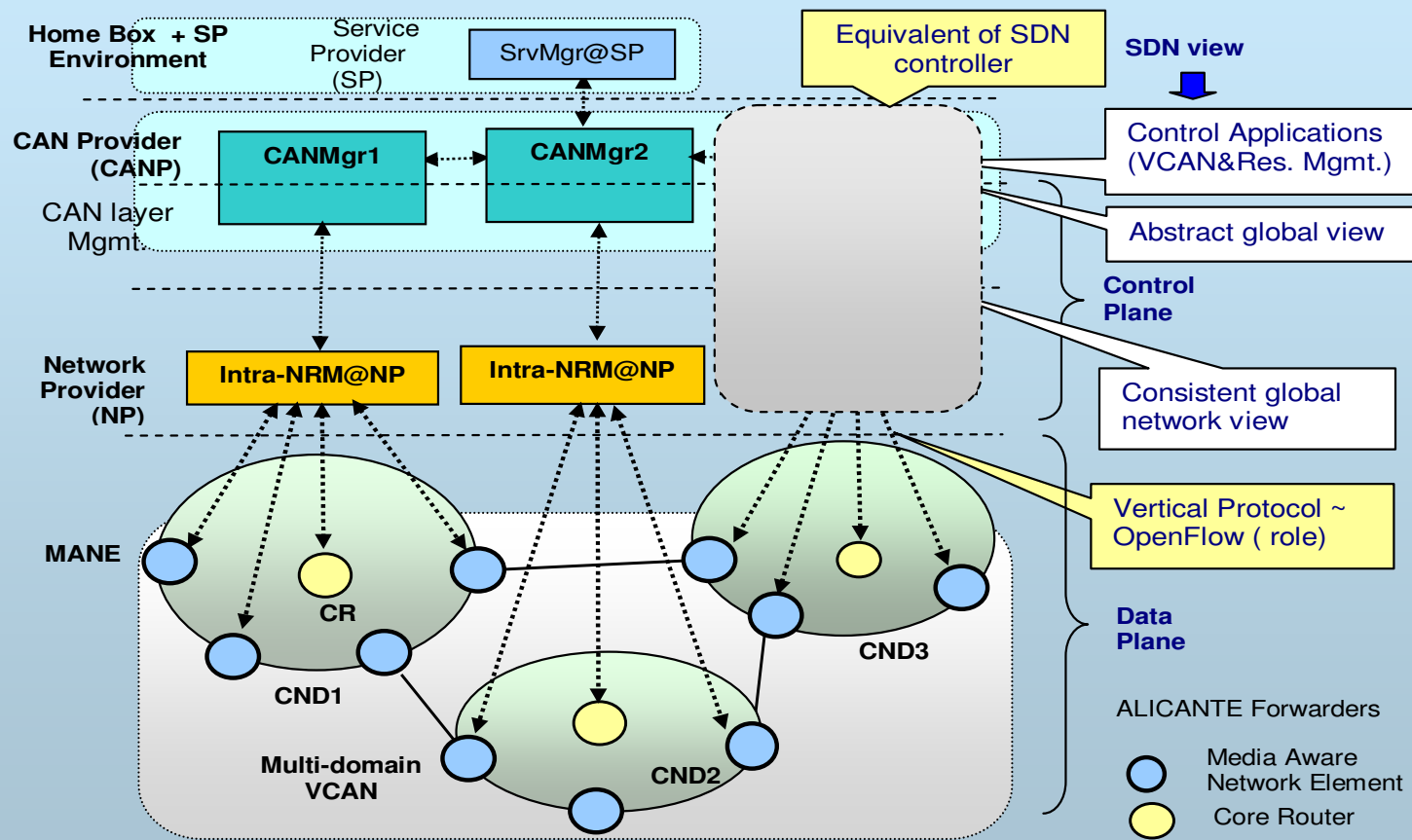



6. ALICANTE Project



- **ALICANTE Architecture- SDN comparison**
-

<i>SDN architecture- main principles</i>	<i>ALICANTE architecture- main principles</i>
Evolutionary architecture	Yes: ALICANTE architecture can be seamlessly deployed
Control Plane / Data Plane separation	Yes: the M&C Planes are separated w.r.t Data Plane. The QoS constrained routing, resource allocation, admission control and VCAN mapping are included in the CAN Manager. The virtualization of the network is performed by CANMgr + Intra-NRM, which hides the characteristics network technology
Network intelligence is (logically) centralized in SW -based SDN controllers, which maintain a global view of the network: maintain, control and program Data Plane state from a central entity	Yes: [CAN Manager + Intra-NRM] play together the role of an SDN controller for a network domain, controlling the MANE edge routers and interior core routers.
Execute Control Plane Infrastructure SW on general purpose HW	Yes: for M&C Planes Yes: even for MANE.
Decoupled from specific networking HW	Yes: the MANE and core routers are viewed by the CAN layer in abstract way
Control Plane can use commodity servers	Yes: CAN Managers and Intra-NRM may use any appropriate general-purpose server.
Data Plane is programmable	Yes: all configurations for MANE and Core routers are determined in CAN and Network M&C and downloaded in the routers.



6. ALICANTE Project



- **ALICANTE Architecture- SDN comparison**
-

<i>SDN architecture- main principles</i>	<i>ALICANTE architecture- main principles</i>
The architecture defines the control for a network (and not for a network device)	Yes: - CAN Manager level: overall image on the static and dynamic characteristics of all VCANs - Intra-NRM level: full control on the forwarders in the network domain associated
The network appears to the applications and policy engines as a single, logical switch.	Yes: in ALICANTE , the network appears at higher layers as a set of parallel planes VCANs
This simplified network abstraction can be efficiently programmed.	Yes: the VCANs are seen at abstract way; they can be planned and provisioned independently of the network technology.
Multi-domain capabilities	Yes : (CANMGr + IntraNRM) play the role of SDN controller
Scalable solutions (distributed network of controllers, aggregation, etc.)	Yes: The control is distributed
Full virtualization (M&C and Data Plane)	No: Only Data Plane is virtualized
Universal Interface Controller- forwarders (Open flow)	No: Specific protocol. Could be replaced by Open flow
Open flow compliant forwarders	No: could be seen as a possible evolution



CONTENTS



1. Software Defined Networks (Basics)
2. SDN Applications
3. SDN-OpenFlow
4. SDN Extensions and Advanced Architectures
5. Other recent technologies- SDN approach
6. SDN-like architecture example : ALICANTE Project
7.  **Conclusions**



7. Conclusions



- **SDN – technology opening new perspective to networking:**
 - Flexibility (decoupling DPL/CPI)
 - Programability
 - Better resource and policy management
 - Network equipment vendor independency
 - No huge problems of scalability (despite some opinions)
 - Can be extended to SDIA

- Incremental deployment – possible
- Strong support from industry

- **Open - research issues**
 - Distributed control plane versus – unique logical representation- in large networks
 - Coordination among several controllers
 - Reliability
 - Universality of API and OpenFlow – like protocol



- Thank you !
- Questions?



References-0



1. N.McKeown, T.Anderson, et. Al., OpenFlow: Enabling Innovation in Campus Networks, - <http://www.openflow.org/documents/openflow-wp-latest.pdf>.
2. M.Mendonca, et. al., A Survey of Software-Defined Networking: Past, Present, and Future of Programmable Networks, <http://hal.inria.fr/hal-00825087/>
3. A. Campbell, I. Katzela, K. Miki, and J. Vicente. Open signaling for atm, internet and mobile networks (opensig'98). ACM SIGCOMM Computer Communication Review, 29(1):97-108, 1999.
4. D. Tennenhouse, et.al., A survey of active network research, Communications Magazine, IEEE, 35(1):80-86, 1997.
5. A. Greenberg, et. al., A clean slate 4d approach to network control and management. ACM SIGCOMM Computer Communication Review, 35(5):41-54, 2005.
6. R. Enns, NETCONF Configuration Protocol RFC 4741 (Proposed Standard), Dec. 2006, Obsoleted by RFC 6241.
7. A. Doria, et al., Forwarding and Control Element Separation (ForCES) Protocol Specification. RFC 5810 (Proposed Standard), Mar. 2010
8. M. Casado, et al., Ethane: Taking control of the enterprise. ACM SIGCOMM Computer Communication Review, 37(4):1-12, 2007.
9. M. Casado, et.al., Fabric: a retrospective on evolving sdn, Proceedings of the first workshop on Hot topics in software defined networks, HotSDN '12, pages 85-90, New York, NY, USA, 2012. ACM.
10. Open networking foundation, <https://www.opennetworking.org/about>.
11. Open Networking Research Center (ONRC). , <http://onrc.net>.
12. Open vswitch and ovs-controller, <http://openvswitch.org/>.
13. Pantou: Openow 1.0 for openwrt, <http://www.openow.org/wk/index.php/>



References-1



14. OpenFlow switch specification v1.0. , <http://openflow.org/wp/documents/>
15. OpenFlow Switch Specification, V 1.3.0 (Wire Protocol 0x04) June 25, 2012
16. HP SDN/Openflow Technology Solutions:
<http://h17007.www1.hp.com/us/en/solutions/technology/openflow/index>
17. SDN Controller Product Fact Sheet:
<http://h17007.www1.hp.com/docs/interopny/4AA4-3881ENW.PDF>
18. SDN for cloud providers and enterprises:
<http://h17007.www1.hp.com/docs/interopny/4AA4-3872ENW.pdf>
19. SDN Technical White Paper <http://h17007.www1.hp.com/docs/interopny/4AA4-3871ENW.pdf>
20. Software-Defined Networking: The New Norm for Networks ONF White Paper April 13, 2012
21. K. Yap, et.al., Blueprint for introducing innovation into wireless mobile networks, proceedings of the second ACM SIGCOMM workshop on Virtualized infrastructure systems and architectures, pages 25-32. ACM, 2010.
22. L. Suresh, et.al., Towards programmable enterprise wlangs with odin, Proceedings of the rst workshop on Hot topics inSDN , HotSDN '12, pages115-120, New York, NY, USA, 2012. ACM
23. M. Bansal, et. al., Openradio: a programmable wireless dataplane, Proceedings of the rst workshop on Hot topics in software dened networks, pages 109-114, ACM, 2012
24. SDN: the service provider perspective, Ericsson Review, February 21, 2013
25. K. Calvert, et.al., Instrumenting home networks. ACM SIGCOMM Computer Communication Review, 41(1):84-89, 2011



References-2



26. N. Feamster. Outsourcing home network security, Proceedings of the 2010 ACM SIGCOMM workshop on Home networks, pages 37-42. ACM, 2010.
27. R. Mortier, et.al., Control and understanding: Owning your home network, communication Systems and Networks (COMSNETS), 2012 Fourth International Conference on, pages 1-10. IEEE, 2012.
28. S. Mehdi,. Revisiting trac anomaly detection using SDN, Recent Advances in Intrusion Detection, pages 161-180. Springer, 2011.
29. S. H.Yeganeh, et.al., On Scalability of Software-Defined Networking, IEEE Comm. Magazine, February 2013
30. A. Tootoonchian et al., "On Controller Performance in Software-Defined Networks," Proc. USENIX Hot-ICE '12, 2012, pp. 10–10
31. M. Yu et al., "Scalable Flow-Based Networking with DIFANE," Proc. ACM SIGCOMM 2010 Conf., 2010, pp. 351–62.
32. A. R. Curtis et al., "DevoFlow: Scaling Flow Management for High-Performance Networks," Proc. ACM SIGCOMM '11, 2011, pp. 254–65.
33. T. Koponen et al., "Onix: A Distributed Control Platform for Large-Scale Production Networks," Proc. 9th USENIX, OSDI Conf., 2010.
34. S. H.Yeganeh and Y. Ganjali, "Kandoo: A Framework for Efficient and Scalable Offloading of Control Applications," Proc. HotSDN '12 Wksp., 2012.
35. A. Tootoonchian et.al., "Hyperflow: A Distributed Control Plane for OpenFlow," Proc. 2010 INMConf., 2010.
36. B. Raghavan, T, et.al., Software-Defined Internet Architecture: Decoupling Architecture from Infrastructure, Hotnets '12, October 29–30, 2012, Seattle, WA, USA



References-3



37. Peter Mell , Timothy Grance, The NIST Definition of Cloud Computing, Special Publication 800-145, Recommendations of the National Institute of Standards and Technology , 2011
38. Fang Liu, Jin Tong, Jian Mao, Robert Bohn, John Messina, Lee Badger and Dawn Leaf, Recommendations of the National Institute of Standards and Technology, NIST “Cloud Computing Reference Architecture”, Special Publication 500-292 , 2011
39. Jamil CHAWKI, “Cloud Computing Standards: Overview and ITU-T positioning”, ITU Workshop on “Cloud Computing” (Tunis, Tunisia, 18-19 June 2012)
40. Marco CARUGI Cloud Computing technology in Telecommunication ecosystems and recent ITU-T standardization efforts, International Workshop “Innovative research directions in the field of telecommunications in the world” within ITU-ZNIIS ITTC joint project 21-22 July 2011, Moscow, Russia
41. ITU-T FG Cloud TR Part 2: Functional requirements and reference architecture
42. W. Liu, J. Ren. J. Wang, IETF, Draft-icn-implementation-sdn-00, „A Unified Framework for Software-Defined Information-Centric Network” August 09, 2013
43. J.Choi, Jinyoung Han, E.Cho, Ted Kwon, and Y.Choi,A Survey on Content-Oriented Networking for Efficient Content Delivery, IEEE Communications Magazine • March 2011
44. T. Koponen et al., “A Data-Oriented (and Beyond) Network Architecture,” SIGCOMM '07, 2007, pp. 181–92
45. D. Kutscher, B.Ahlgren, H.Karl, B. Ohlman, S.Oueslati I.Solis, Information-Centric Networking— Dagstuhl Seminar — 2011
46. A.Ghods, T.Koponen, B.Raghavan, S.Shenker, A.Singla, J.Wilcox, Information-Centric Networking: Seeing the Forest for the Trees, <http://www.icsi.berkeley.edu/~barath/papers/icn-hotnets11.pdf>



References-4



47. Operator Network Monetization Through OpenFlow-Enabled SDN, ONF Solution Brief, April 3, 2013, <https://www.opennetworking.org/images/stories/downloads/sdn-resources/solution-briefs/sb-network-monetization.pdf>
48. G. Pavlou, Information-Centric Networking: Overview, Current State and Key Challenges, IEEE ISCC 2011 Keynote <http://www.ee.ucl.ac.uk/~gpavlou/>
49. D. Kutscher, B.Ahlgren, H.Karl, B. Ohlman, S.Oueslati I.Solis, Information-Centric Networking— Dagstuhl Seminar — 2011
50. Van Jacobson, D.K. Smetters, J.D. Thornton, M. F. Plass, NH. Briggs, R.L. Braynard, Networking Named Content, Palo Alto Research Center, Palo Alto, CA, October 2009
51. H. Koumaras, et.al., “Media Ecosystems: A Novel Approach for Content-Awareness in Future Networks”, Future Internet: Achievements and Promising Technology, Springer Verlag, pp369-380, May 2011
52. E.Borcoci (UPB), et.al., "A Novel Architecture for Multimedia Distribution based on Content-Aware Networking", Proc. of the 3rd Int'l. Conference on Communication Theory, Reliability, and Quality of Service (CTRQ 2010), Athens/Glyfada, Greece, June 13-19, 2010,
53. E.Borcoci, R.Iorga (UPB) “A Management Architecture for a Multi-domain Content-Aware Network”, TEMU Conf, Int'l Conf. on Telecommunications and Multimedia, 14-16 July, 2010, Crete, Greece.
54. E.Borcoci, et. al., “Resource Management in Multi-Domain Content-Aware Networks for Multimedia Applications” , Int'l. Journal on Advances in Networks and Services”, vol 5 no 1 & 2, year 2012, http://www.iariajournals.org/networks_and_services/